

ergoselect 12

Stress Echo Couch Ergometer

Operator's Manual

201000515000 • Version 2020-01-14 / Rev 02 • English



Manual

ergoselect 12
Stress Echo Couch Ergometer
Operator's Manual

201000515000 • Version 2020-01-14 / Rev 02 • English

This manual was written with the utmost care. Should you still find details that do not correspond with the system, please let us know and we will correct the issue as soon as possible.

We reserve the right to modify the design and technical features of the device and are not bound by the information and illustrations provided in this manual.

All trademarks appearing in this document are trademarks of their respective owners. Their protection is acknowledged.

No part of this manual may be reprinted, translated or reproduced without the manufacturer's written permission.

This manual will not be automatically updated. Please contact the manufacturer for the latest document revision.

This manual also describes optional components that are not included in the standard scope of delivery of this product.

ergoline GmbH
Lindenstraße 5
72475 Bitz
Germany

Tel.: +49-(0) 7431 98 94 - 0
Fax: +49-(0) 7431 98 94 - 128
e-mail: info@ergoline.com
http: www.ergoline.com







Contents

1	General Information	5
2	Safety Information	6
2.1	Safety Information for Non-Invasive Blood Pressure Measurement	7
2.2	Contraindications	7
2.3	Intended Use	7
2.4	Biocompatibility	7
2.5	Applicable Laws, Regulations and Directives	8
3	Symbols	9
4	Setup and Mains Connection	10
4.1	Controls and Indicators	10
4.2	Transport	10
4.3	Setup	11
4.4	Mounting Attachment Parts	11
4.5	Connecting the Power Cord	13
4.6	Connecting the ECG Cable	14
4.7	Start-up and Preparation	14
5	Operation	16
5.1	Adjusting the Couch	16
5.2	Saving Couch Positions	16
5.3	Recalling Couch Positions	16
5.4	Emergency Lowering	16
6	Preparing the Patient	17
6.1	Preparing the Couch with the Patient	17
7	Preparing the Patient for Blood Pressure Measurements	18
7.1	Cuff Size	18
7.2	Microphone Position	18
7.3	Applying the Cuff	19
8	Control Terminals	20
8.1	Control Terminal D/M	20
8.1.1	Turning the System On	20
8.1.2	Operating Mode with Control Terminal D/M	21
8.2	Control Terminal P	22
8.2.1	Turning the System On	22
8.2.2	Operating Modes	23
8.3	Control Terminal T	32
8.3.1	Turning the System On	32
8.3.2	Operating Modes with Control Terminal T	33

9	Cleaning, Maintenance, Disposal	47
9.1	General Cleaning	47
9.2	Cleaning the Upholstery	47
9.3	Cleaning the Saddle	47
9.4	Disinfection	47
9.5	Cleaning the Blood Pressure Cuff	48
9.5.1	Removing the Microphone	48
9.5.2	Cleaning	48
9.5.3	Disinfection	48
9.5.4	Inserting the Microphone	49
9.6	Maintenance	49
9.6.1	Checks Before Each Use	49
9.6.2	Technical Safety Inspections and Inspections of the Measuring System	49
9.7	Disposal	49
10	Technical Specifications	50
10.1	Ergometer	50
10.2	Blood Pressure Module	51
10.3	Exercise Test Protocols	52
10.4	Test Protocols (control terminal T only)	52
10.5	Family of characteristics of the braking torque control range	53
10.6	Family of characteristics of the load periods according to IEC 60601-1	53
11	Electromagnetic Compatibility EN 60601-1-2	54
12	Mounting the Safety Belt	58

1 General Information

- The product ergoselect bears the CE marking CE-0123 (Notified Body: TÜV), indicating its compliance with the provisions of the Council Directive 93/42/EEC about medical devices and fulfills the essential requirements of Annex I of this directive.
The CE marking covers only the accessories listed in the Order Information chapter. The device is an MDD class IIa product.
- The device fulfills the requirements of the standard EN 60601-1 "Medical electrical equipment, Part 1: General Requirements for Safety" as well as the interference protection requirements of standard EN 60601-1-2 "Electromagnetic Compatibility – Medical Electrical Devices".
The radio-interference emitted by this device is within the limits specified in EN 55011, class A.
- The symbol  means: protective ground.
- This manual is an integral part of the device. It should be available to the equipment operator at all times. Close observance of the information given in the manual is a prerequisite for proper device performance and correct operation and ensures patient and operator safety. Please note that information pertinent to several chapters is given only once. Therefore, read the manual once carefully in its entirety.
- The symbols   mean:
Consult accompanying documents.
They indicate points that are of particular importance in the operation of the device.
- Observance of the safety information protects from injuries and prevents inappropriate use of the device. All device users and persons responsible for assembly, maintenance, inspection and repair of the device must read and understand the content of this manual, before using the device or working with it. Paragraphs with special symbols are of particular importance.
- Opening the control terminal will destroy the calibration stick. Any warranty claim shall become void as a result.
- This manual reflects the device specifications and applicable safety standards valid at the time of printing. All rights are reserved for devices, circuits, techniques, software programs, and names appearing in this manual.
- On request ergoline GmbH will provide a Field Service Manual.
- The implemented quality management system covers all aspects of the ergoline GmbH operations as per EN ISO 13485: 2016.
- The safety information given in this manual is classified as follows:

Danger

indicates an imminent hazard. If not avoided, the hazard will result in death or serious injury.

Warning

indicates a hazard. If not avoided, the hazard may result in minor injury and/or product/property damage.

Caution

indicates a potential hazard. If not avoided, the hazard may result in minor injury and/or product/property damage.

- To ensure patient safety, the specified measuring accuracy, and interference-free operation, we recommend using only original ergoline GmbH accessories. The user is responsible if accessories from other manufacturers are used.
- ergoline GmbH is responsible for the safety, reliability, and performance of the device, only if
 - assembly operations, extensions, readjustments, modifications, or repairs are carried out by ergoline GmbH or by an organization expressly authorized by ergoline GmbH to carry out these tasks
 - the equipment is used in accordance with the instructions given in this operator manual.

2 Safety Information

Danger

- Explosion Hazard •

The device is not designed for use in areas where an explosion hazard may occur.

Explosion hazards may result from the use of flammable anesthetics, skin cleansing agents, or disinfectants.

Warning

- Patient Hazard, Equipment Damage •

Do not expose the ergoselect to direct sunlight to prevent system components from reaching inadmissible high temperatures.

Do NOT use the ergoselect outdoors (medical device). Furthermore the device has no additional protection against the ingress of humidity. Humidity inside the device may cause equipment malfunctions and increases the risk of an electric shock.

Additionally, the device should not be operated in the vicinity of power systems, because they may impair equipment functions.

The ergoselect may only be used in combination with accessories approved by ergoline GmbH.

- Risk to Persons •

Before using the ergometer, the operator must ascertain that it is in correct working order and operating condition. The cables and connectors, in particular, must be checked for signs of damage. Damaged parts must be replaced immediately.

- Equipment Malfunction •

Only the special shielded cables supplied by ergoline GmbH may be used to connect the device to other pieces of equipment.

- Equipment Malfunction •

Cellular telephones may not be used in the immediate vicinity of the ergometer, because they might interfere with the proper functioning of the ergometer.

Electromagnetic interference most probably exists when the watt reading is unstable. If the displayed value changes frequently even though the speed is above 30 RPM, this may be due to electromagnetic interference.

Note

The device characteristics determined by emissions allow the device to be used in industrial environments and in hospitals (CISPR 11, class A). When used in domestic surroundings (which normally requires compliance with CISPR 11 class B), the device may not offer adequate protection for radio services. If required, the user may have to take remedial action by relocating or re-orienting the device.

Warning

- Shock Hazard •

When the device is connected to other equipment or if a medical system is created, it must be ensured that the added leakage currents do not present a hazard. In case of questions, please contact your ergoline dealer or the ergoline GmbH Service Department.

For use, the ergometer must always be connected to electric installations that fulfill the local requirements.

- Patient Hazard •

The German Medical Device Operator Ordinance (MPBetreibV, § 5) demands that users

- *must be trained in the use of the ergometer*
- *must be familiar with the routines for handling and assembly of the device*
- *must be familiar with and observe the safety rules and regulations for operation of this type of equipment*
- *must be informed about any other pertinent rules and regulations (e.g., safety instructions)*
- *must be informed about the potential hazards arising from the use of this type of equipment*
- *make sure that no unauthorized changes are carried out.*

- Patient Hazard •

Only properly trained and appropriately qualified personnel is allowed to operate and work with the medical device.

Note

Only the removal of the power cord will result in an all-pole disconnection of the device from the power line.

Caution

Additional equipment connected to medical electrical equipment must comply with the respective IEC or ISO standards (e.g., IEC 60950 for data processing equipment).

Furthermore all configurations shall comply with the requirements for medical electrical systems (see IEC 60601-1-1 or clause 16 of the 3rd edition of IEC 60601-1, respectively).

Anybody connecting additional equipment to medical electrical equipment configures a medical system and is therefore responsible for the system's compliance with the requirements for medical electrical systems. Attention is drawn to the fact that local laws take priority over the above mentioned requirements.

If in doubt, please consult your local dealer or ergoline GmbH.

2.1 Safety Information for Non-Invasive Blood Pressure Measurement

Warning

• Patient Hazard •

Do not take blood pressure measurements with a cuff on patients suffering from sickle cell anemia or if skin lesions are likely to occur.

The cuff may cause hematomas in patients with severe blood coagulation disease. In these instances, the user must take a decision for or against automatic blood pressure measurements.

Caution

• Compromised Measuring Accuracy •

Arrhythmias occurring frequently during a measurement may compromise the accuracy of the measurement.

Valid measurements may not be possible under certain circumstances.

Electromagnetic fields are also capable of impairing the measuring accuracy.

Note

- *If the cuff pressure exceeds the maximum value of 300 mmHg during inflation, the inflation procedure will be aborted and the cuff deflated. As a redundant safety precaution, the cuff is immediately deflated when the cuff pressure exceeds 320 mmHg.*
You can check the proper functioning of this safety precaution by abruptly bending your arm while the cuff is being inflated, causing a brief overpressure in the cuff. The cuff must deflate immediately.
- *Measurements that do not yield a valid measurement will not be repeated during the exercise test.*
- *If the inflation phase takes longer than 40 seconds or if an adequate pressure does not build up in the cuff within a reasonable period of time, the measurement will be aborted and the cuff deflated.*
- *If a valid measurement cannot be completed within 120 seconds, the measurement will be aborted and the cuff deflated.*
- *If the cuff pressure remains constant for some time, the measurement will also be aborted and the cuff deflated.*

2.2 Contraindications

The following patient categories are excluded from using the device:

- patients feeling discomfort or suffering from dizziness, nausea or pain.
- patients under the influence of substances that may impair vigilance (alcohol, drugs, medication).

Contraindications in exercise testing carried out with ergometers

(source: Banerjee A et al., 2012)

Contraindications in exercise testing:

- acute myocardial infarction in the previous 4 to 6 days
- unstable angina with rest pain in the previous 48 hours
- uncontrolled heart failure
- acute myocarditis or pericarditis
- acute systemic infection
- deep vein thrombosis as it is likely to shift and cause pulmonary embolism
- uncontrolled hypertension with systolic blood pressure > 220 mmHg or diastolic blood pressure > 120 mmHg
- severe aortic stenosis
- severe hypertrophic obstructive cardiomyopathy
- untreated life-threatening arrhythmia
- dissecting aneurysm
- recent aortic surgery
- abnormalities during testing include:
 - abnormal ST-segment response (horizontal, planar or down-sloping depression of > 1 mm).
 - T-wave elevation of > 1 mm in leads without Q-waves.
 - T-wave changes such as inversion and pseudo-normalization when an inverted T-wave becomes upright are non-specific changes.

Criteria for stopping bicycle-based exercise testing

(source: Banerjee A et al., 2012).

Criteria for stopping bicycle based exercise testing include:

ECG criteria

- severe ST depression of > 3 mm
- ST elevation > 1 mm in non-Q-wave lead
- frequent ventricular extra systoles
- onset of ventricular tachycardia
- new atrial fibrillation or supraventricular tachycardia
- development of new bundle branch block
- progression of heart block to second or third degree
- cardiac arrest

Clinical criteria

- excessive fatigue
- severe chest pain, dyspnea, or dizziness
- > 20 mmHg reduction in systolic blood pressure
- rise in blood pressure

2.3 Intended Use

The ergoselect 12 is a computer-controlled medical ergometer, which operates at pedal speeds between 30 and 130 RPM and loads between 6 and 999 W.

The speed-independent range is shown in the Appendix (Technical Specifications).

The ergoselect ergometers may only be used in exercise testing and for rehabilitation of cardiac and cardiovascular patients according to the instructions given in this manual. If the ergometer is used for other purposes, the manufacturer cannot be held liable for personal injuries or property damage resulting from the unintended use of the equipment.

Note – Applied Parts

- *Applied parts are components that are directly in contact with the human body (e.g., blood pressure measuring devices).*

Note – Stability

- *Ensure the stability of the ergometer. If the maximum permitted patient weight is exceeded by +10%, the stability of the ergometer can no longer be guaranteed. It may become unstable as a result.*

2.4 Biocompatibility

The parts of the product described in this manual, including all accessories that come in contact with the patient during the intended use, fulfill the biocompatibility requirements of the applicable standards if applied as intended.

If you have questions in this matter, please contact ergoline GmbH or an ergoline GmbH representative.

2.5 Applicable Laws, Regulations and Directives

If you have questions about the validity of applicable laws, regulations and directives, please contact ergoline GmbH.

3 Symbols



Symbol 'type B applied part'
Type B applied parts have no direct contact with patients and offer the lowest protection against electric shock.



Symbol 'type BF applied part'
Type BF applied parts are connected to the body of the patient and provide a higher degree of protection against electric shock. The applied parts are isolated.



Caution: Consult accompanying documents.



Protective ground.



This symbol indicates that the waste of electrical and electronic equipment must not be disposed of as unsorted municipal waste and must be collected separately.
Consult Operating Manual!



Order number.



Serial number.



Scheduled date of the next inspection
(e.g., March 2020).



Toggle switch ON (voltage).



Toggle switch OFF (voltage).



CE mark per the Medical Device Directive 93/42/EEC of the European Union.
Notified body: TÜV SÜD Product Service GmbH, Ridlerstr. 65, 80339 München, Germany.



Nationally Recognized Testing Laboratory
NRTL label for the USA and Canada.



Emergency lowering
button OFF (stable position)
button ON (only while button is being pressed)



Manufacturer's identification.



Date of manufacture
The number found under this symbol is the date of manufacture in the YYYY-MM-DD format.



PVC-free.



Latex-free.



Suitable for the indicated arm circumference.



Small size.



Standard size.



Large size.



Transport and storage label:
top.



Transport and storage label:
keep dry.



Transport and storage label:
fragile.



Transport and storage label:
approved temperature range.



Transport and storage label:
approved humidity range, non-condensing.



Transport and storage label:
approved pressure range.



Transport and storage label:
do not stack.

4 Setup and Mains Connection

4.1 Controls and Indicators

- 1 Handgrip
- 2 Knob for adjustment of the headrest
- 3 Speed readout for the patient
- 4 Arm rest for blood pressure measurements (right or left, only on devices with automatic blood pressure measurement)
- 5 Connections for blood pressure cuff (below the couch surface)
- 6 Release lever for ergometry unit
- 7 Connections for power cord and connection cables (under the cover)
- 8 Crepe table paper roll
- 9 Emergency lowering button (on the underside of the couch)
- 10 Underarm support, adjustable
- 11 Drop section
- 12 Release lever for drop section
- 13 Hip support, adjustable
- 14 Type plate (on the back of the table column)
- 15 Remote control

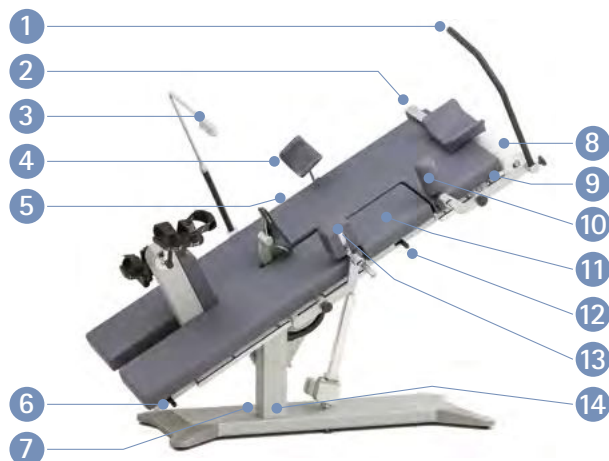

Figure 4-1: ergoselect 12 components and controls



Figure 4-2: Remote control

4.2 Transport

The ergoselect 12 is quite large and heavy. Therefore, the couch ergometer will be shipped to you and set up by a qualified carrier.

Caution

- Equipment Damage •

Avoid strong vibrations of the couch ergometer during transport.

4.3 Setup

Several persons should be present to set up the ergoselect 12.

The ergoselect 12 must be set up on a horizontal level floor.

The couch ergometer must be set up in a secure and stable position! The leveling feet make for easy adjustment to uneven floors.

During setup, the six leveling feet need to be screwed into the baseplate. To do this, place the couch ergometer carefully on one side and screw the leveling feet into the corresponding borings (see figure 4-3) and align.

Screw in the feet so the couch ergometer is standing securely; tighten the counter nut with an open-end wrench (see figure 4-4).

In case of delicate flooring, it is recommended to place a mat under the ergometer to protect the flooring from damage by the feet.

Caution

- Patient Hazard / Equipment Damage •

During assembly, the ergometer must be disconnected from the power line.

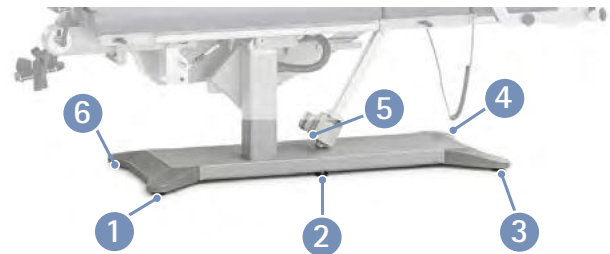

Figure 4-3: Position of the leveling feet

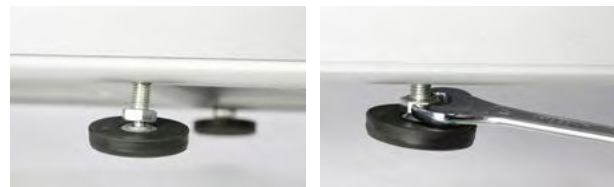

Figure 4-4: Aligning the leveling feet

4.4 Mounting Attachment Parts

- Generally you slide the attachment parts onto the standard rails ① on the side and secure them.
- Loosen the set screw ② of the attachment part before placing it on the standard rail.
- Always position and move the attachment parts carefully on the standard rail ③. Do not force the attachment parts onto the standard rail!
- Slide the attachment part to the appropriate position ④ and secure by tightening the set screw ②.

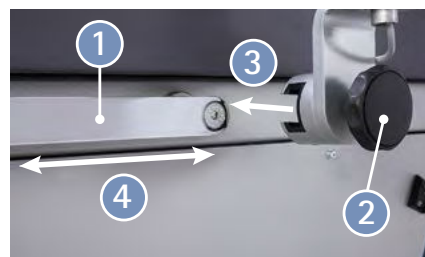

Figure 4-5: Mounting attachment parts

Note

- Patient Safety •

Always secure attachment parts by turning the set screw clockwise.

When mounting attachment parts with perforated rails, make sure that the bolts of the knobs engage properly in the rails before tightening the knobs by turning them clockwise.

4 Setup and Mains Connection

- Mount the holder for the exam table paper roll by means of two countersunk screws M6x20 **1** which are screwed into the frame.

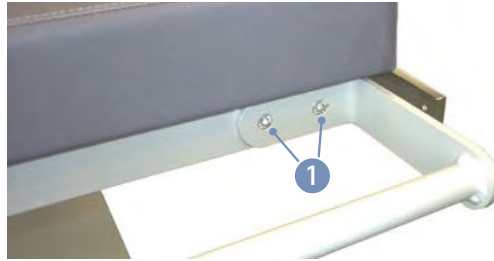

Figure 4-6: Mounting the holder for the exam table paper roll

Caution

- **Equipment Damage** •

Use only white exam table paper.
Colored paper may leave stains on the padded surface.

- Install, position, and secure the handgrip **1**.
- Install, position, and secure the headrest **2**.
- Install, position, and secure the speed readout for the patient **3**.
- Install, position, and secure the bracket for the armrest **4** on the right or left standard rail (only on devices with blood pressure module).
- Connect the blood pressure cuff **5** (see Figure f-8).
- Introduce the saddle post **6** in the saddle guide rail (see Figure f-9).
- Attach the crepe table paper roll to the holder **7**.
- Install, position, and secure the underarm support **8**.
- Install, position, and secure the hip support **9**.

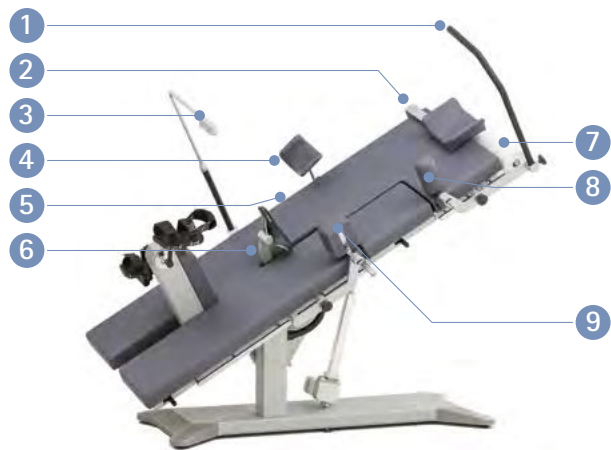

Figure 4-7: Mounting attachment parts

Note

- Tighten the set screw only as much as necessary, **NOT** with maximum force.
- Grease the threads of the set screws every 3 months at minimum, using a suitable grease, such as OKS470.

- Insert the microphone connector of the blood pressure cuff into the socket **1** and press down until it locks into place.
- Insert the tube connector of the blood pressure cuff into the socket **2** until the retaining ring locks into place.
- Check the cuff tubes and make sure they are not kinked or bent.

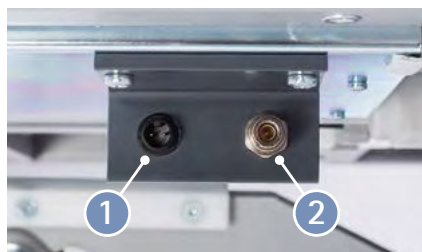

Figure 4-8: Connecting the blood pressure cuff

- 1** Socket for microphone connector
- 2** Socket for tube connector

- Introduce the saddle post into the saddle guide rail **1** and press down lightly until the post locks into place.

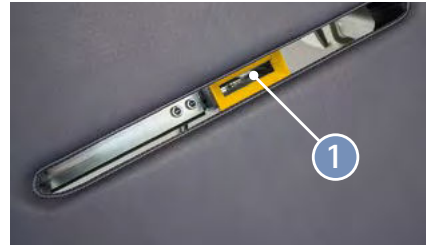

Figure 4-9: Introducing the saddle post into the guide rail

Caution

- Equipment Damage •

If your ergometer has a separate control terminal, be sure to route the connection cable to the control terminal out of the way to prevent any stumbling hazard. Furthermore, protect the control terminal from falling down.

4.5 Connecting the Power Cord

The connection panel is located in the baseplate under a cover.

- Plug the power cord into the socket.
- Secure the power cord with a strain relief.



Figure 4-10: Connection panel in the baseplate

- 1** Socket for power plug
- 2** Socket for USB connector, type B
- 3** Socket for digital connection (Port 1)
- 4** Cover

Warning

- Equipment Damage •

For operation, the ergometer must be connected to a properly installed, grounded power socket.

Caution

- Equipment Damage •

Before connecting the ergometer to the power line, check that the line voltage corresponds to the ratings on the type plate. The type plate is located at the bottom of the table column.

4.6 Connecting the ECG Cable

The ergoselect ergometers can be connected to electrocardiographs and PC-based ECG systems of most manufacturers.

Different connection cables are available to support different communication modes (digital, analog, remote start, etc.).

All ergoselect ergometers are equipped with a digital interface.

(Special adapters are needed for analog control or the remote start capability. Please contact ergoline GmbH for these adapters.)

The connection cable is plugged into the USB port ① or the 9-pole socket of the connection panel (Port 1) ② and secured at the metal frame with an additional strain relief.



Figure 4 – 11: Connection for ECG recorder/PC ECG system

- ① USB PC connection via USB (virtual COM)
- ② Port 1 Digital connection (remote control from PC or ECG recorder), connection for cable adapter (analog interface + remote start)

Note

• Disconnection from Power Supply •

Pressing the power switch or removing the power cord disconnects the device from the power supply.

Removing the power cord results in a complete disconnection of the device from the power supply (all poles).

Ensure that the power plug is readily accessible at all times.

Note

• Connection Cables •

Use only connection cables approved by ergoline GmbH.

A special PC driver software, which can be obtained from ergoline GmbH, is required for operation via the USB port.

4.7 Start-up and Preparation

- ① MCU (Motor Control Unit) power supply
240 V DC
- ② P2: Patch cable for control terminal (types M, P, T)
- ③ P3: Patch cable for external speed readout
- ④ H: ATE wheel speed sensor
- ⑤ R1: Remote control cable or receiver for remote control by radio signal
- ⑥ R2: free (not assigned)
- ⑦ E: Emergency lowering button



Figure 4 – 12: Connections

Concerning its functionality, the control terminal on the underside of the couch ergometer is equivalent to control terminal M (see chapter 8.1 *Control Terminal D/M* on page 20).

For putting the unit into service, remove the control terminal from below the couch surface. Use a 4-mm Allen key to loosen the two screws ①.

The control terminal allows you to adjust a number of parameters (such as the baud rate, EKG type) before use, or to initiate a manual blood pressure measurement.

These adjustments should be referred to a qualified service Engineer.



Figure 4-13: Control terminal under the couch surface

5 Operation

5.1 Adjusting the Couch

The saddle and the couch position are adjusted with the remote control (see figure 5–1).

- Keys 1: saddle adjustment
- Keys 2: keys for storage of couch positions
- Keys 3: incline adjustment (0 to 45°)
- Keys 4: lateral tilt adjustment (0 to 45°)
- Key 5: memory key

The yellow indicator 6 is illuminated while any of the adjustment keys is pressed.

All movements stop automatically when the end position is reached. Movements also stop when two adjustment keys for a motor are pressed at the same time.

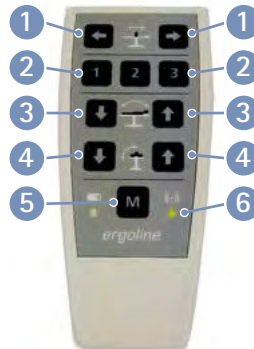

Figure 5–1: Remote control

5.2 Saving Couch Positions

- Adjust the appropriate couch position with keys 1, 3 and 4.
- Press key "M", and then press key "1", "2" or "3" 2 at the same time.
The position is now saved to this key.

Caution

- Patient Hazard •

The arm rest (for blood pressure measurements) is not designed to support the full body weight and it must not be used as a support when getting on and off the couch.

5.3 Recalling Couch Positions

- Press and hold one of the keys "1", "2" or "3" 2.
- The stored couch position is automatically adjusted. The movements of the two motors are synchronized; therefore, the position is reached in less time than with a manual adjustment.

Note

- Motors •

The motors are not designed for continuous operation. The duty cycle of 10% (1 min ON/9 min OFF) must be observed. This means that 1 minute of continuous operation of the control terminal must be followed by a pause of 9 minutes.

5.4 Emergency Lowering

If a power failure occurs while a patient is lying on the couch (both motors extended), the emergency lowering button allows the motors to be retracted even if no power is supplied. The patient will be able to get off the couch without any problems.



Figure 5–2: Emergency lowering button

6 Preparing the Patient

6.1 Preparing the Couch with the Patient

Before the patient can lie down on the couch, the ergometer must be prepared as follows:

- Restore the lateral tilt to the horizontal position.
- Lower the saddle to the bottom position.
- Remove the saddle.
- Check that the padded drop section ① (see figure 6 – 1) is securely in place.
- Adjust the incline until the couch is horizontal so the patient can get on the couch without any problems.
- Adjust the hip and underarm support as well as the armrest to a position where they are out of the way when the patient gets on the couch.
- Retract the pedal unit.
- Ask the patient to lie down on the couch.
- Reinstall the saddle.
- Fold out the pedal unit.
- Close the straps at both pedals and secure the feet in the pedal shoes by means of the hook and loop fasteners of the straps.

There should be a 10° angle between the axis formed by the upper body and the thigh when the pedal is in its bottom position.

- Adjust the saddle until this angle is achieved.
- Adjust the headrest until in contact with the shoulder, when the head is placed on the head rest.
- Fold down the drop section using the release lever.
- Set the hip support to a position where it will not hinder the patient during the exercise and secure it in this position.
- Set the underarm support to the correct position.
- Choose a position for the speed readout where the patient can easily read the displayed values.

Now you can adjust the incline and the lateral tilt of the couch.

Note

- Patient Safety •

When the pedal unit is retracted, the couch surface cannot be inclined laterally.



Figure 6 – 1: Closed drop section

Note

- Patient Safety •

Always secure attachment parts by turning the set screw clockwise.

When mounting attachment parts with perforated rails, make sure that the bolts of the knobs engage properly in the rails before tightening the knobs by turning them clockwise.

Note

- Motors •

The controller is not suitable for continuous operation. The duty cycle of 10% (1 min ON/9 min OFF) must be observed. This means that 1 minute of continuous operation of the control terminal must be followed by a pause of 9 minutes.

7 Preparing the Patient for Blood Pressure Measurements

7.1 Cuff Size

Always choose the cuff size suitable for the patient's arm.

The maximum arm circumference is indicated on the cuff.

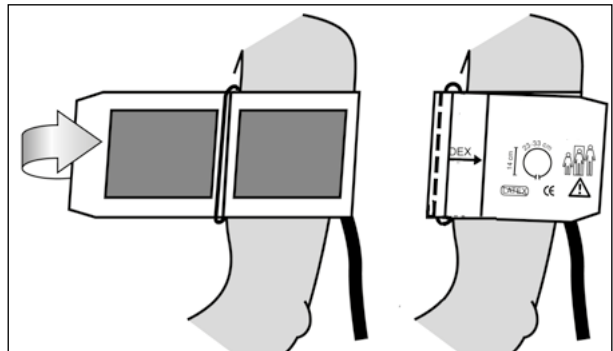

Figure 7-1: Correct cuff size

When you close the Velcro strap, check that the metal clasp

① is inside the marked index range ②, and not outside (see figure 7-2).

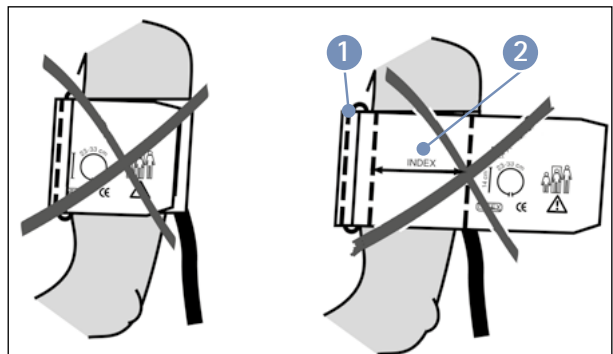

Figure 7-2: Wrong cuff size

7.2 Microphone Position

Before applying the cuff, check the position of the microphone inside the red pocket (on the inside of the cuff):

When the microphone is inside the pocket, its **metal side must face the arm**.

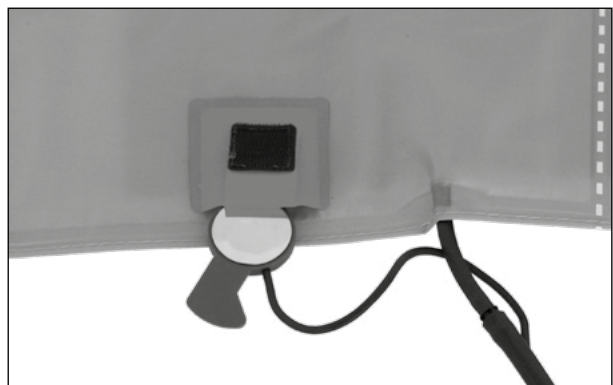

Figure 7-3: Correct microphone position

7.3 Applying the Cuff

The center of the microphone must be located exactly on the **brachial artery**. Locate the artery by palpation if required.

The **red tab** identifies the position of the microphone.

The accurate placement of the microphone is the primary condition for reliable pressure measurement during exercise tests. The cuff must be applied directly on the skin, it may not be applied on top of clothing, paper, etc. Apply the cuff approx. **2 cm above the bend of the elbow**. The cuff should be **tight**, but it should not constrict blood vessels. Make sure that the cuff **cannot shift** when the patient moves during the exercise test.

The cuff tab must be located below the metal clasp (see figure 7–5).

Instruct your patient to move as little as possible during a blood pressure measurement and, in particular, to avoid excessive contractions of the muscles in the upper arm.

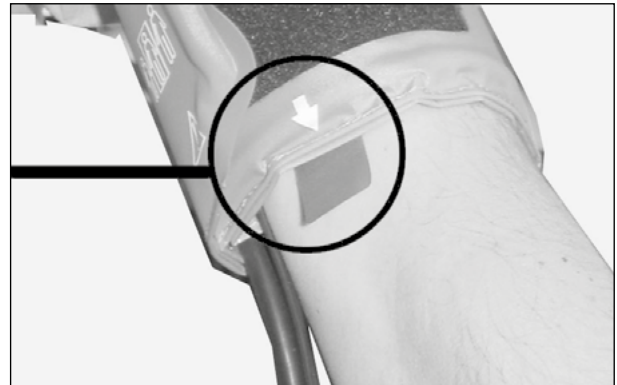

Figure 7–4: Microphone placement on the artery

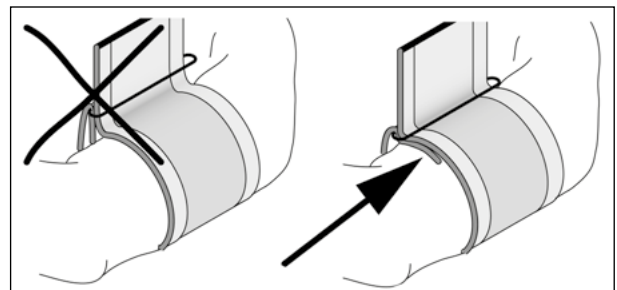

Figure 7–5: Correct cuff position (tab)

Caution

• Patient Hazard •

Apply the cuff directly on the skin. Make sure that rolled up sleeves do not impede blood circulation in the upper arm. Loose cuffs will cause erroneous measurements; overtight cuffs may constrict blood vessels or cause skin lesions and hematomas.

• Incorrect Measurements •

A loose cuff would degrade the accuracy of the measurement. Therefore, the computer aborts the measurement if a minimum pressure is not attained within a few seconds.

Warning

• Patient Hazard •

If, by accident, an excessive pressure builds up inside the cuff, either remove the cuff immediately from the arm or disconnect the cuff tubing from the control terminal. The same measures are recommended if the cuff does not deflate correctly.

8 Control Terminals

8.1 Control Terminal D/M



Figure 8-1: Control terminal D (Service)
(installed under the couch surface – standard)



Figure 8-2: Control terminal M (remote control)
(separate terminal – option)

The two terminals are identical in operating routines and functionality.

8.1.1 Turning the System On

You turn on the ergometer by pressing the power switch. The ergometer runs a self-test. Subsequently, the start screen displays.

Control terminals D/M are entirely operated by remote control (e.g., from an ECG recorder or a PC).

 With this key you initiate a blood pressure measurement. Pressing the key a second time during a measurement will stop the measurement.



Figure 8-3: Start screen

Note

- Instruct the patient not to pedal while the ergometer is being turned on and during the self-test.
- Apply the blood pressure cuff to the patient AFTER the ergometer has been turned on and the self-test completed.

8.1.2 Operating Mode with Control Terminal D/M

Ergometers with control terminal D/M support the following operating mode:

PC Mode

An external device (e.g., an ECG recorder, a PC-based ECG system) controls the ergometer – no intervention at all is required at the couch ergometer.

When the ergometer is switched on, the display shows the start screen – the ergometer is waiting for commands from the external ECG unit.



Figure 8-4: Start screen

As soon as the ergometer receives commands from the controlling ECG unit or PC, the exercise test will start and the corresponding values will be displayed.

The exercise test can only be terminated with the corresponding command from the controlling ECG unit.

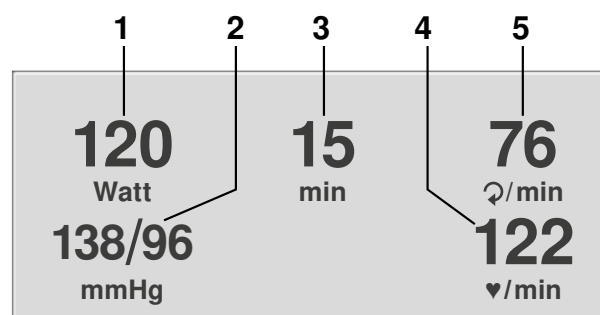

Figure 8-5: Exercise test screen 1

- 1 current load (Watt)
- 2 most recent BP value (systolic / diastolic) or cuff pressure during inflation and bar graph indicating microphone signal strength (see below)
- 3 duration of exercise test (min)
- 4 heart rate at the time of the BP measurement (BPM)
- 5 pedal speed (RPM)



Figure 8-6: Exercise test screen 2

8.2 Control Terminal P

8.2.1 Turning the System On

You turn on the ergometer by pressing the power switch (toggle switch [1/0]). The ergometer runs a self-test. Subsequently, the main menu displays.

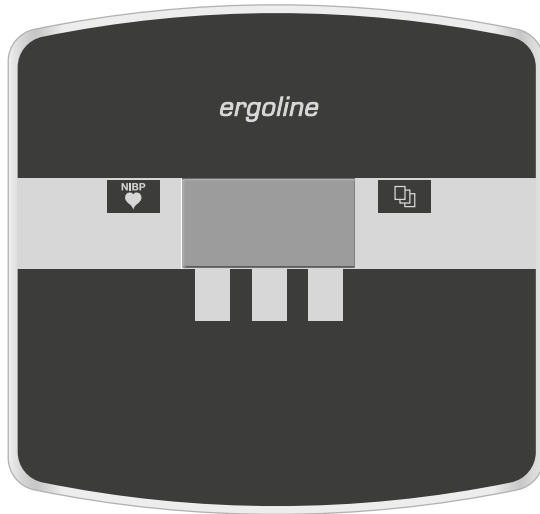



Figure 8-7: Control terminal P

Note

- Instruct the patient not to pedal while the ergometer is being turned on and during the self-test.
- Apply the blood pressure cuff to the patient AFTER the ergometer has been turned on and the self-test completed.
- The device can be configured to default to one of the operating modes.

If this option is selected, the start screen of the selected operating mode (e.g., Ergometry) will be displayed instead of the main menu.

With the  key, you can display the main menu.

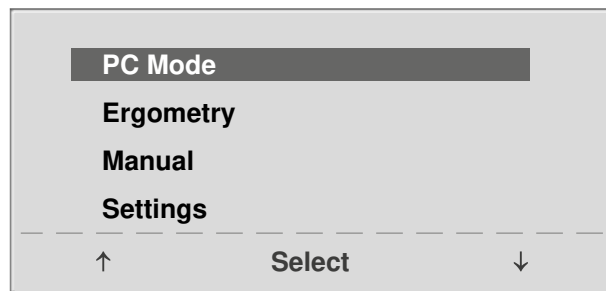





Figure 8-8: Main menu

The ergometer software is controlled with 5 keys:

 With this key you display the main menu or return to the previous menu level.

 With this key you initiate a blood pressure measurement. A measurement in progress can be aborted with the same key.

 The functions of these three softkeys change with the displayed menu – the key label describing the function is shown on the display.

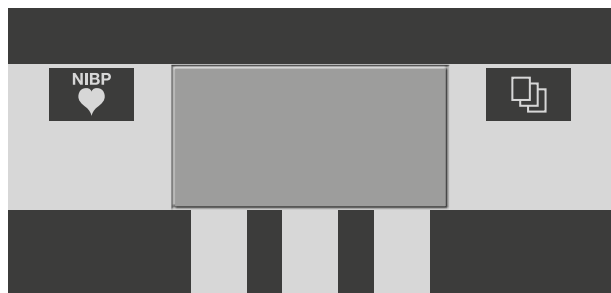

Figure 8-9: Keypad P

8.2.2 Operating Modes

Ergometers with control terminal P support the following operating modes:

PC Mode

An external device (e.g., an ECG recorder, a PC-based ECG system) controls the ergometer – no intervention at all is required at the ergometer.

Ergometry

The ergometer runs an automatic exercise test – some of the corresponding test protocols are user-configurable and stored in the system (see chapter 8.2.2.4 *Settings with Control Terminal P* on page 27).

Manual

The ergometer is controlled manually, i.e., the user performs all load changes via the keypad.

Settings

Used to configure the ergometer.

8.2.2.1 PC Mode

Use the softkeys on the right and left (↑ ↓) to position the bar cursor on **PC Mode** and confirm the selection with **Select**.

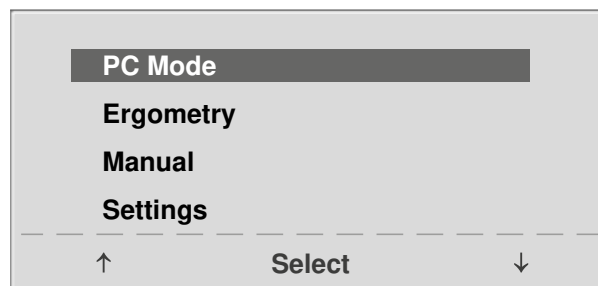

Figure 8 – 10: Main menu

The start screen will be displayed – the ergometer is waiting for commands from the external ECG unit.

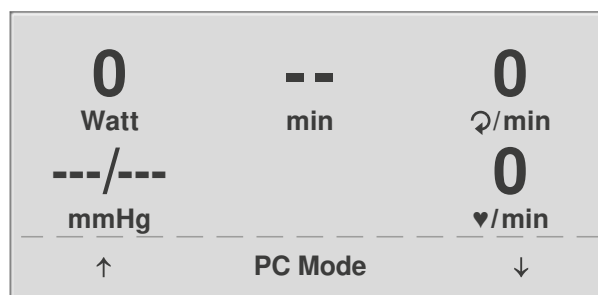

Figure 8 – 11: Start screen

8 Control Terminals

As soon as the ergometer receives commands from the controlling ECG unit or PC, the exercise test will start and the corresponding values will be displayed.

The exercise test can only be terminated with the corresponding command from the controlling ECG unit.

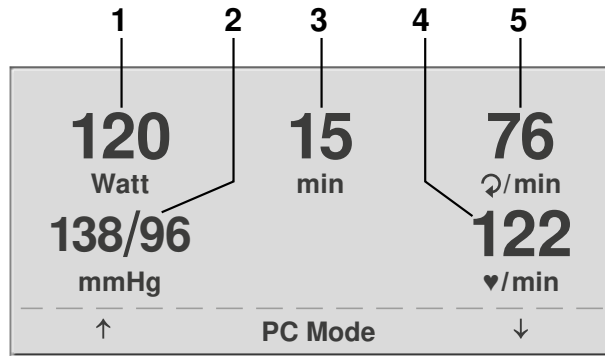



Figure 8-12: Exercise test screen 1

- 1 current load (Watt)
- 2 most recent BP value (systolic/diastolic) or cuff pressure during inflation and bar graph indicating microphone signal strength (see below)
- 3 duration of exercise test (min)
- 4 heart rate at the time of the BP measurement (BPM)
- 5 pedal speed (RPM)

Note

- All functions are locked while the ergometer is operating in PC mode, except for the saddle height adjustment and the blood pressure key.
- To reactivate the saddle height adjustment function, press  and the arrow keys will again be displayed.
- Additional blood pressure measurements can be initiated with .

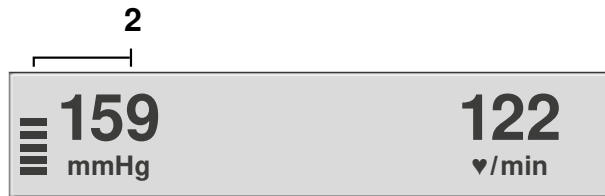

Figure 8-13: Exercise test screen 2

8.2.2.2 Ergometry

Use the softkeys on the right and left (↑ ↓) to position the bar cursor on **Ergometry** and confirm the selection with **Select**.

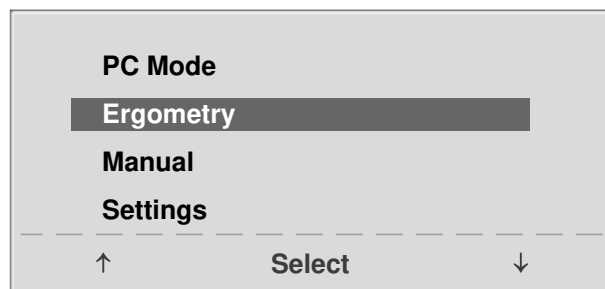

Figure 8-14: Main menu

The stored test protocols available for selection will be displayed. There are five fixed protocols (protocols 1 to 5, (see chapter 10.3 *Exercise Test Protocols* on page 52)), whereas protocols 6 to 15 are user-programmable.

The protocol menu provides an overview of the test phases.

Example: **50 W/2 min/25 W**

indicates: Basic load of 50 W
Stage time of 2 min
Load stage of 25 W

Use the softkeys on the right and left (↑ ↓) to position the bar cursor on one of the protocols and confirm the selection with **Select**.

The exercise test is started with the **Start** key, a blood pressure measurement at rest may precede the test (depending on the selected exercise test protocol).

When the basic load appears on the display (after approx. 15 seconds or upon termination of the blood pressure measurement) and the patient's RPM indicator blinks, the patient should start pedaling.

The internal protocol will now control the entire exercise test – the display always indicates the current values.

With the +5 W and –5 W keys, the current load can be changed any time (in increments of +/-1 W up to +/-25 W, as configured).

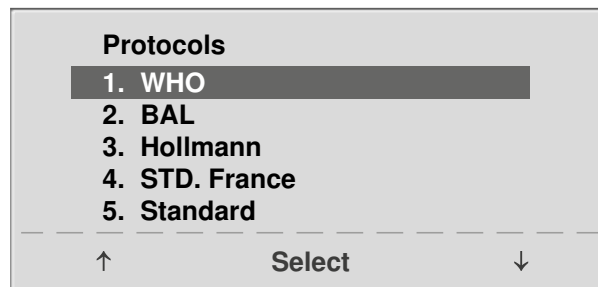

Figure 8-15: Selecting an exercise test protocol

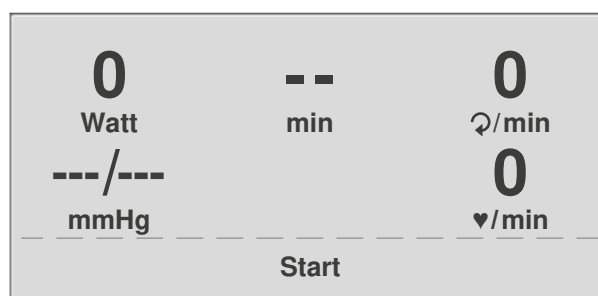

Figure 8-16: Start of an exercise test

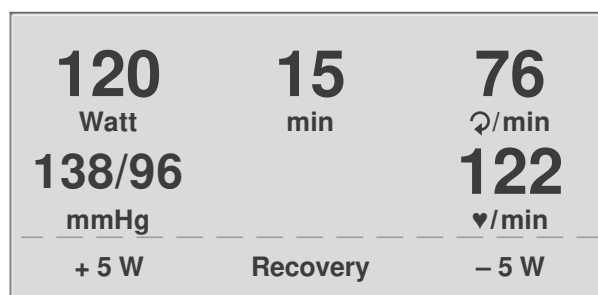



Figure 8-17: Display during the exercise test

Note

- The saddle height can be adjusted during an exercise test.
- To activate the saddle height adjustment, press  : the arrow keys will be displayed then.
- Additional blood pressure measurements can be initiated with .

Terminating an Exercise Test

The exercise phase can be terminated manually at any time with the **Recovery** key.

The load will immediately be reduced to 25 watts, but a higher or lower value can be selected manually.

It is recommended that the patient continue to pedal in the recovery phase.

The **End** key in the middle will terminate the test.

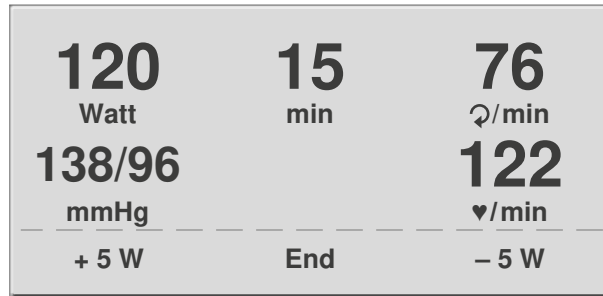

Figure 8-18: Recovery phase

8.2.2.3 Manual

Use the softkeys on the right and left (↑ ↓) to position the bar cursor on **Manual** and confirm the selection with **Select**.

In this operating mode the user controls the entire exercise test by selecting the loads, stage times and by initiating blood pressure measurements.

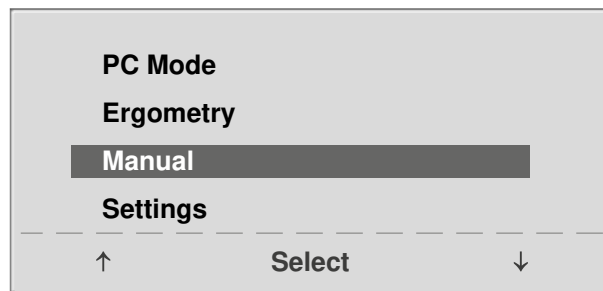

Figure 8-19: Main menu

The exercise test is started with the **Start** key, afterwards the load can be set and changed with the +5 W and -5 W keys (in increments of +/-1 W up to +/-25 W, as configured).

Blood pressure measurements can be initiated with .



Figure 8-20: Initial screen of a manual exercise test

Terminating an Exercise Test

The exercise test can be terminated manually at any time with the **End** key located in the middle.

The load will immediately drop to 0 watt.

There is no recovery phase in the manual mode.

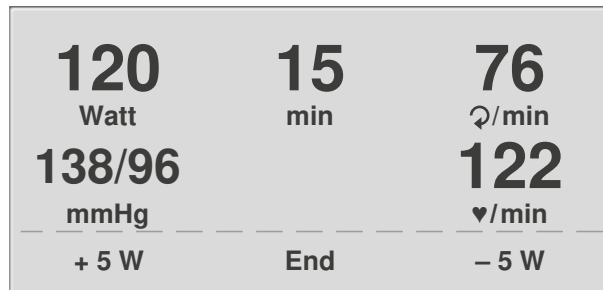



Figure 8-21: Display during the exercise test

8.2.2.4 Settings with Control Terminal P

Some of the device settings are configurable to meet specific requirements. The settings will be saved and remain stored even when the ergometer is switched off.

Use the softkeys on the right and left (↑ ↓) to position the bar cursor on **Settings** and confirm the selection with **Select**.

The configuration menu displays.

When all changes have been made, you can exit the configuration menu with the  key.

Use the softkeys on the right and left (↑ ↓) to position the bar cursor on the parameter to change and confirm the selection with **Select**.

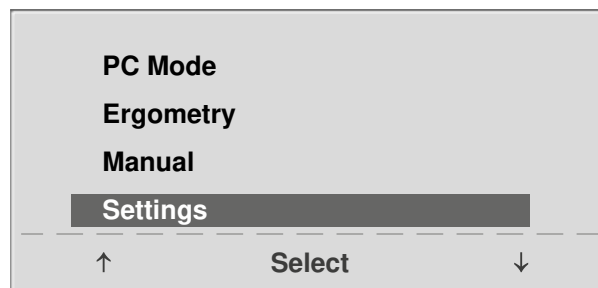

Figure 8-22: Main menu

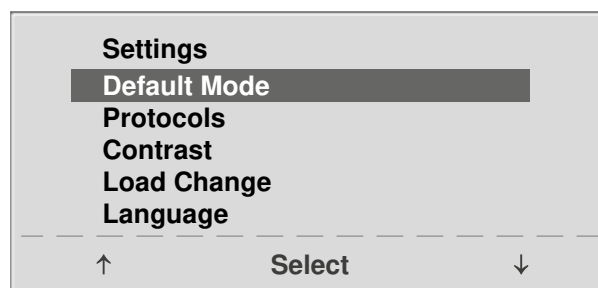

Figure 8-23: Settings menu

Default Mode

In this menu you choose the default mode activated when the ergometer is turned on. When first turned on after delivery, the ergometer will display this menu.

Use the softkeys on the right and left (↑ ↓) to position the bar cursor on your preferred default mode and save the selection with **Select**.

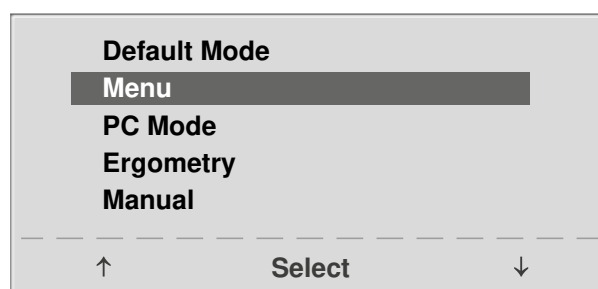

Figure 8-24: Selecting the default mode

Protocols

Protocols 6 to 15 are user-programmable (protocols 1 to 5 are fixed, see chapter 10.3 *Exercise Test Protocols* on page 52 for protocol parameter details). Default values can be entered for the following parameters:

- protocol type (Step/Ramp)
- basic load
- stage time
- load stage (load increase with each stage)

Use the softkeys on the right and left (↑ ↓) to position the bar cursor on the protocol to change (No. 6 to 15) and confirm the selection with **Select**.

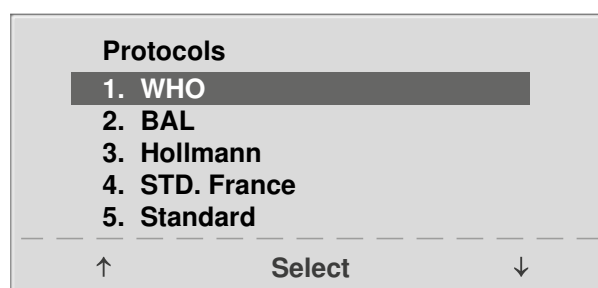

Figure 8-25: Selecting the exercise test protocol to configure

8 Control Terminals

Use the right and left softkeys (↑ ↓) to select the parameter to edit.

At **Select**, for example, you can choose the protocol type:

- Step (load increase in steps) or
- Ramp (continuous load increase).

Press **Select** to save the selected protocol type.

To cancel the selection, press the  key.

All other parameters are edited in the same way.

Using the arrow keys (↑ ↓), highlight a parameter and confirm the selection with **Select**: the corresponding value appears in reverse video and can be changed with the arrow keys (↑ ↓).

Pressing **Select** will save the new value.

You exit the configuration with .

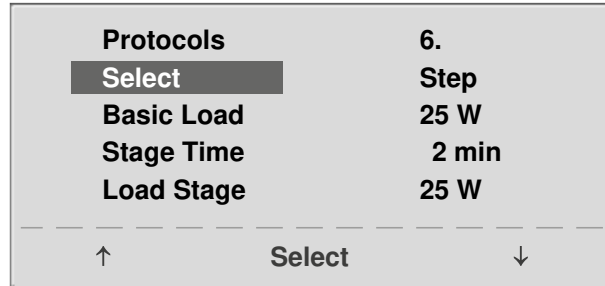

Figure 8–26: Selecting the parameter to edit

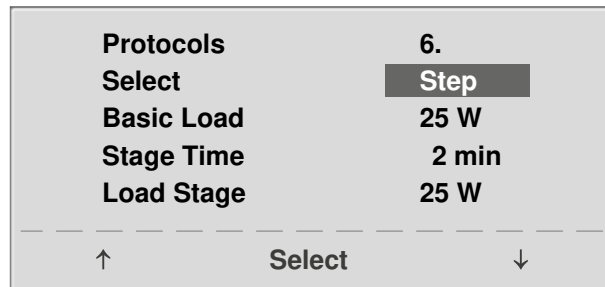

Figure 8–27: Editing the parameter value

Contrast

The display contrast is adjustable in the range from 0 to 100%.

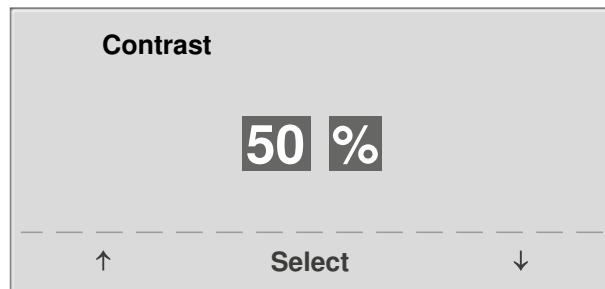

Figure 8–28: Adjusting the display contrast

Load Change

Here you determine the increments for each load change. Depending on your choice, each key press will change the load by +/- 1, 5, 10 or 25 watts.

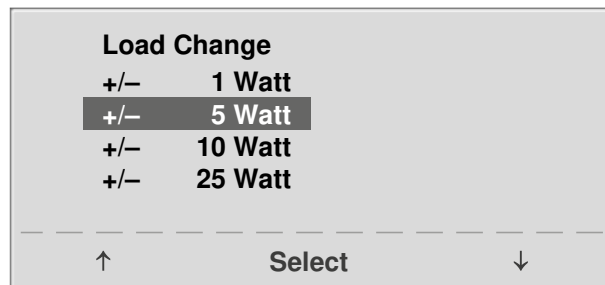

Figure 8–29: Selecting the increment for manual load changes

Language

The texts can be displayed in different languages.

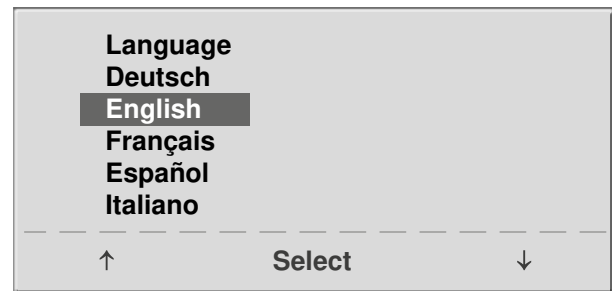

Figure 8–30: Language menu

Beep

The audio signal emitted during blood pressure measurements can be turned on and off.

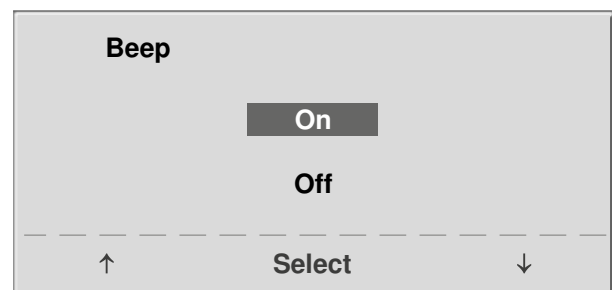



Figure 8–31: Beep during BP measurements

Software Version

Select this option to view the installed software version.

Date/Time

To begin with, you select **Date** and confirm the selection. Then the value displayed in reverse video can be edited with the $\uparrow \downarrow$ keys and saved with **Select**.

The time is adjusted in the same way. You exit the configuration with .

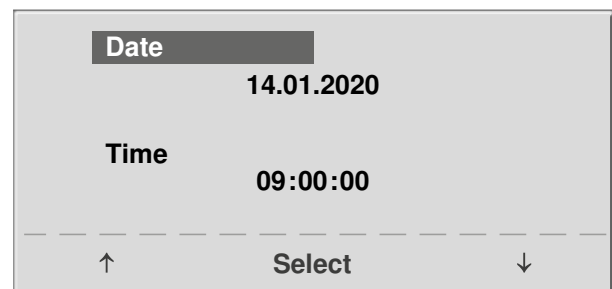

Figure 8–32: Setting the date

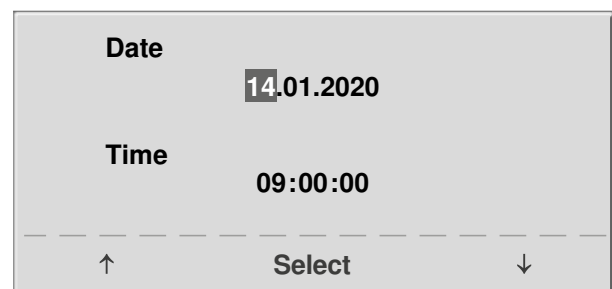

Figure 8–33: Setting the day

ECG Type

The selected ECG Type determines the communication method with the ECG recorder, PC-based ECG system, etc.

To prevent an accidental change of this setting, the menu is protected with a password. Using the arrow keys, enter 003 and confirm the entry with **Select**.

All ergometers support the following communication modes:

- **Analog with pulse**
Remote start mode; before advancing to the next load level, the ergometer generates a control pulse and sends the corresponding data via the interface.
- **Analog/Digital**
An analog voltage controls the load – blood pressure measurements can be initiated with digital commands.
- **Digital (default)**
The communication with the ergometer is entirely controlled with digital commands.
- **Analog IN-OUT**
The entire communication (load control and BP measurements) is controlled with analog signals. No digital data will be sent.

Select the communication mode and confirm with **Select**.

Note

- The ECG Type needs to be selected only when the ergometer is connected to an ECG unit. The selection is part of the installation procedure.
- The "Analog/Digital" and "Digital" communication is only possible when PC Mode is selected from the main menu or when this is the default mode.

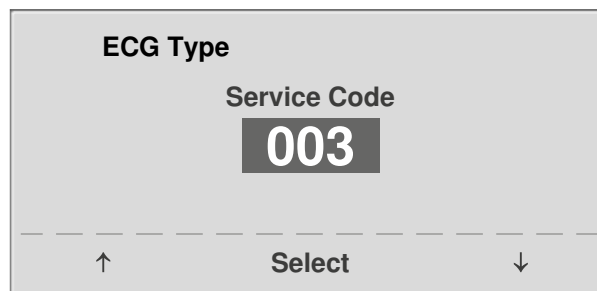

Figure 8–34: Entering the ECG Type password

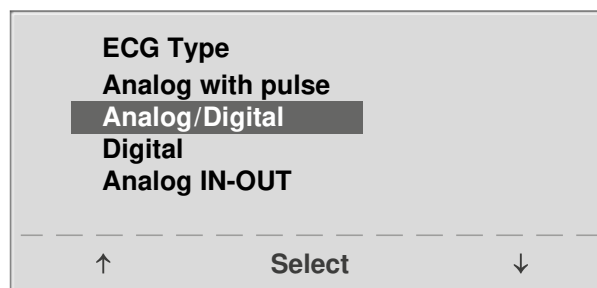

Figure 8–35: Selecting the ergometer communication mode

RPM

Here you determine the RPM limits. When these limits are exceeded, the LEDs for high or low speed (RPM) will illuminate.

Select the value to change (Min. or Max.) and confirm with **Select**.

Using the arrow keys, change the value and save the new value with **Select**.

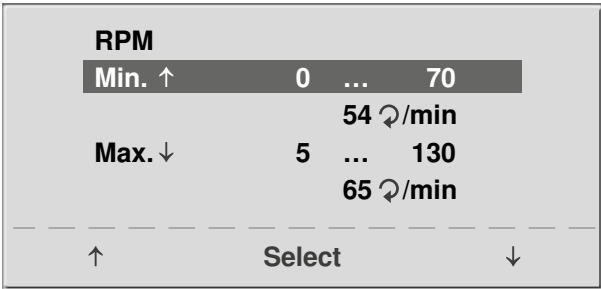

Figure 8-36: Setting the RPM limit values

Note

The limits selected in this menu only apply to the load range between 6 and 150 watts. At higher loads the RPM limits automatically adapt to the respective loads:

Load (watts)	Green RPM range (1/min)
6 - 150	54 - 64 (adjustable)
151 - 250	58 - 65
251 - 350	68 - 75
351 - 450	78 - 85
451 - 550	88 - 95
551 - 650	98 - 105
651 - 750	108 - 115
751 - 850	118 - 125
851 - 950	> 125
951 - 999	> 130

Pulse Display

The pulse readout on the display can be turned off.

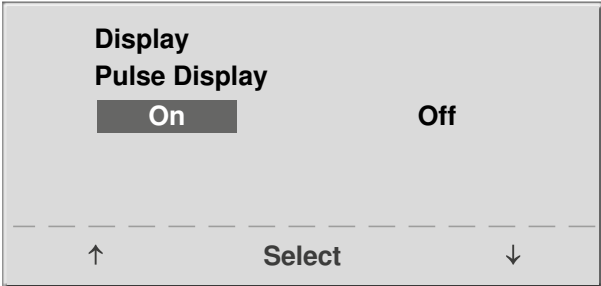

Figure 8-37: Setting the pulse readout

8.3 Control Terminal T

8.3.1 Turning the System On

You turn on the couch ergometer by pressing the power switch (toggle switch [I/O]).

Note

- *Instruct the patient not to pedal while the ergometer is being turned on and during the self-test.*
- *Apply the blood pressure cuff to the patient AFTER the ergometer has been turned on and the self-test completed.*
- *The device can be configured to default to one of the operating modes. If this option is selected, the start screen of the selected operating mode (e.g., Ergometry) will be displayed instead of the main menu.*

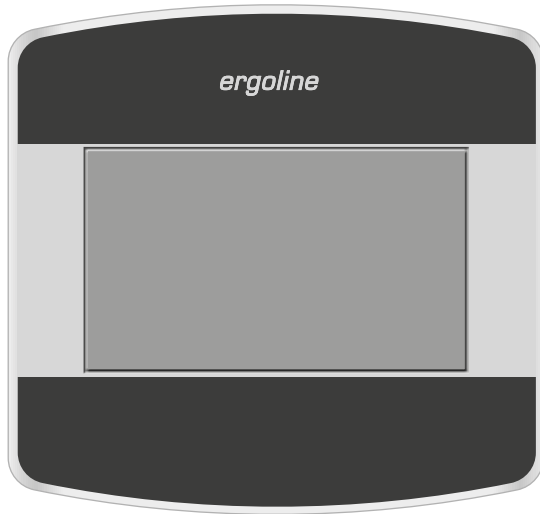

Figure 8 – 38: Control terminal T

The couch ergometer runs a self-test. Subsequently, the main menu displays.



Figure 8 – 39: Self-test screen

The ergometer software is controlled from the touch panel.

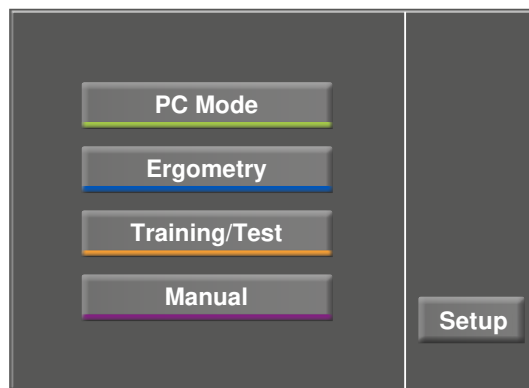

Figure 8 – 40: Main menu

8.3.2 Operating Modes with Control Terminal T

Couch ergometers with control terminal T support the following operating modes:

PC Mode

An external device (e.g., an ECG recorder, a PC-based ECG system) controls the ergometer – no intervention at all is required at the couch ergometer.

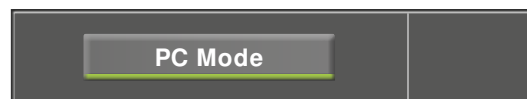

Figure 8-41: PC mode

Ergometry

The couch ergometer runs an automatic exercise test – the available protocols (5 preconfigured, editable protocols and 5 user-configurable protocols are saved in the ergometer (see chapter 8.3.2.2 *Ergometry*, section *Settings* on page 35).

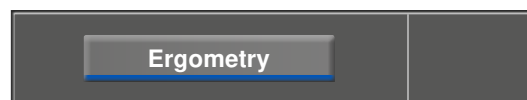

Figure 8-42: Ergometry mode

Training/Test

Ten user-configurable training/test protocols are available (see chapter 8.3.2.3 *Training/Test* on page 37).

A POLAR receiver is integrated in the couch ergometer and provides the relevant data for heart-rate controlled training sessions. The test subject's performance can be assessed on the basis of these protocols.

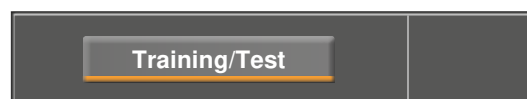

Figure 8-43: Training/Test mode

Manual

The couch ergometer is controlled manually, i.e., the user performs all load changes via the touch panel.

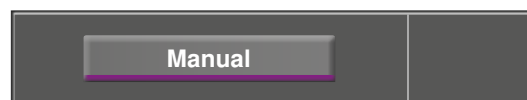

Figure 8-44: Manual mode

Setup

Used to configure the couch ergometer.



Figure 8-45: Setup mode

8.3.2.1 PC Mode

When the [PC Mode] key has been pressed, the screen appears as shown at right. The couch ergometer is waiting for commands from the external ECG unit.

As soon as the ergometer receives commands from the controlling ECG unit or PC, the exercise test will start and the corresponding values will be displayed.

The display shows heart rate (1/min), blood pressure (mmHg), oxygen saturation in percent (%), duration of the exercise test (min:ss), pedal speed (1/min) and current load (W).

The exercise test can only be terminated with the corresponding command from the controlling ECG unit.

A blood pressure measurement can be initiated with the [RR] key. Pressing the [RR] key a second time during a measurement will stop the measurement.

When you press the [ECG] key, the display will change. The acquired, electrical signals will be displayed. The amplitude (gain) can be adjusted with the arrow keys [▲] and [▼].

The pump for the electrode suction system can be switched on and off with the [I/O] key.

You can change the vacuum intensity between low, medium and high by touching the [I/O] key.

To switch off the pump, press the appropriate key [low], [middle], [high] for about 3 seconds.

Confirm all inputs with the [✓] key.

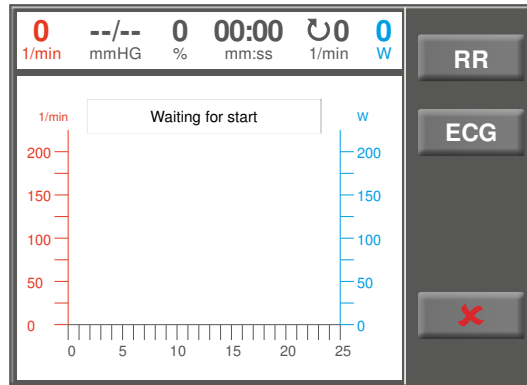

Figure 8 – 46: PC mode screen

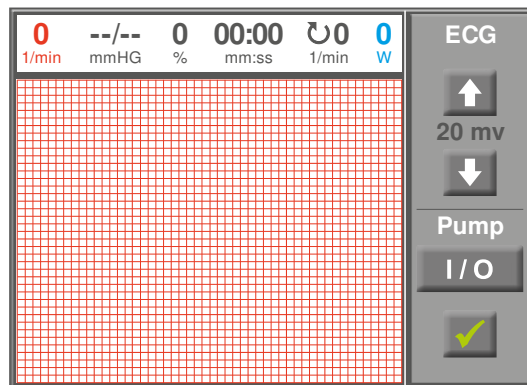

Figure 8 – 47: ECG screen

8.3.2.2 Ergometry

Pressing the [Ergometry] key in the main menu activates the ergometry mode.

The different exercise test protocols will be displayed (5 preconfigured, editable and 5 user-configurable protocols).

All exercise test protocols (including the 5 preconfigured protocols) are editable.

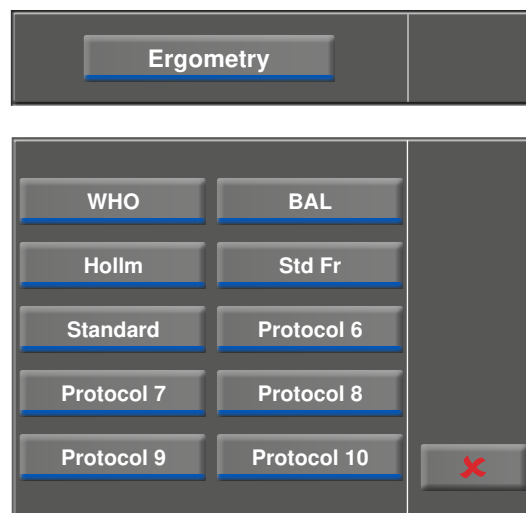

Figure 8 – 48: Ergometry menu

Settings

When you touch a protocol, the available parameters will be displayed.

With the [Edit] key, you can modify each protocol parameter. The new inputs overwrite the existing values.

All protocols can be edited during operation (except for the PC mode).

To permanently save user-programmed protocols, the [Setup] key in the main menu must be pressed (see chapter 8.3.2.5 *Setup*, , section *Protocols* on page 40).

In the configuration menu, the following parameters can be edited:

- the basic load (from 6 to 100 W),
- the stage time (form 1 to 30 min),
- the stage rate (increment, from 1 to 400 W).

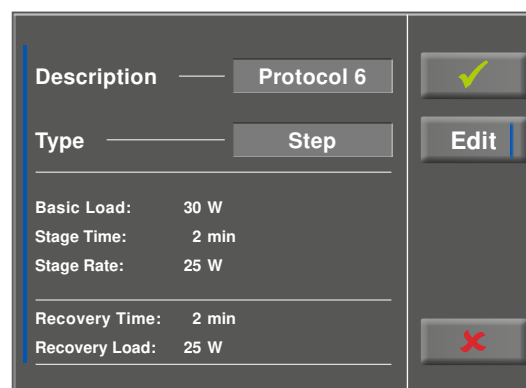

Figure 8 – 49: Exercise test protocol – screen 1

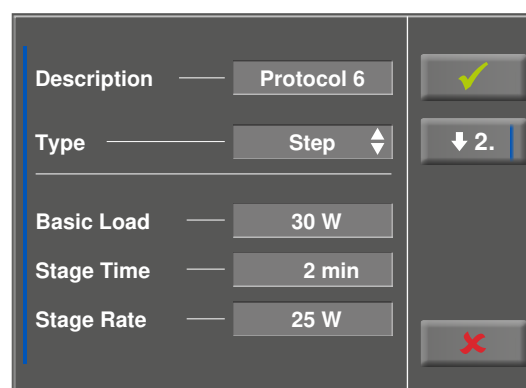

Figure 8 – 50: Exercise test protocol – screen 2

8 Control Terminals

With the [\blacktriangledown 2.] key, you proceed to the next menu level where you can edit these parameters:

- the recovery load (from 6 to 100 W) and
- the recovery time (from 1 to 30 min).

With the [\blacktriangle 1.] key, you return to the previous screen.

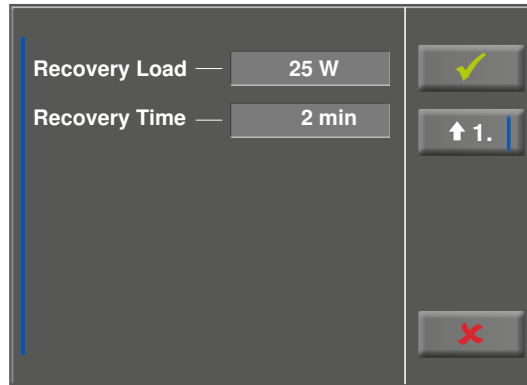

Figure 8–51: Exercise test protocol, basic load – screen 1

Touch a light gray field, e.g., at Basic Load: a submenu with input field and numeric keypad opens. You can enter values directly via the numeric keypad.

Confirm your inputs with the [\checkmark] key. To cancel the input, press the [\times] key.

The other parameters can be edited in the same way, they will overwrite the current values.

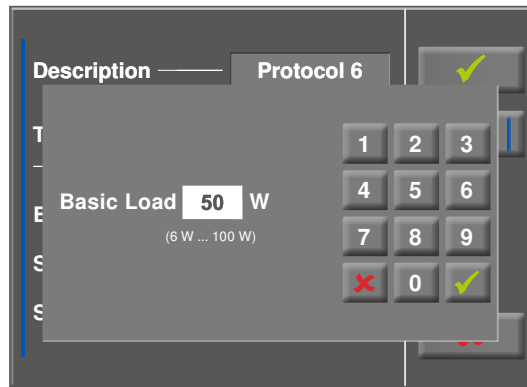

Figure 8–52: Exercise test protocol, basic load – screen 2

When you touch the [\checkmark] key again after confirming, the display will change. Touching the [Start] key on the display will initiate the training session. The session is entirely controlled by the protocol. The display indicates the current values.

When you press the [const.] key, the current load will be maintained for the rest of the session.

You change the load with the [+ 5 W] and [- 5 W] keys. The actual load change can be set in the configuration menu between +/- 1 W and +/- 25 W (see chapter 8.3.2.5 *Setup*, section *Load Change* on page 42).

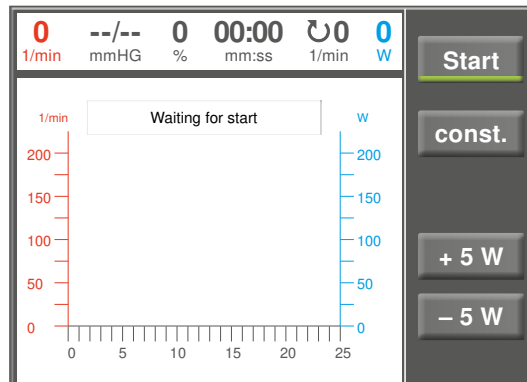

Figure 8–53: Starting an exercise test

Terminating the Program

Once the full protocol has been completed, it terminates automatically.

The program can be terminated manually before the end of the protocol with [Stop]. First, you enter the recovery phase.

When you touch [Stop] again, the training will be terminated.

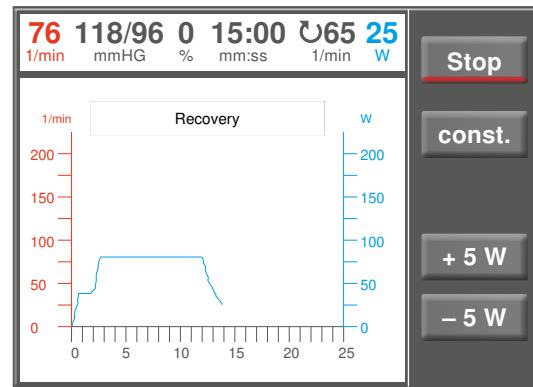

Figure 8 – 54: Terminating an exercise – screen 1

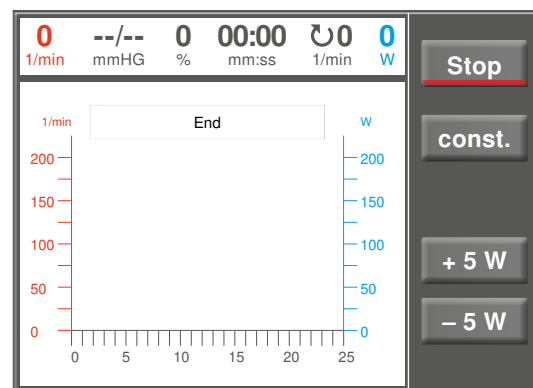

Figure 8 – 55: Terminating an exercise – screen 2

8.3.2.3 Training/Test

Ten different protocols are available in the Training/Test menu.

To edit the protocol parameters, first touch the Training/Test protocol you want to edit.

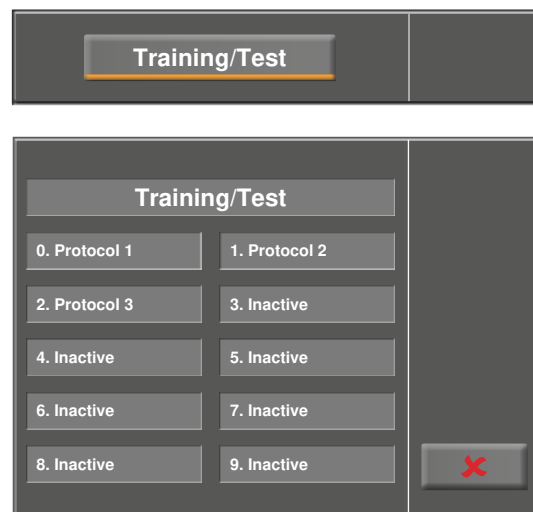

Figure 8 – 56: Training/Test mode selected

8 Control Terminals

Then press the [Edit] key.



Figure 8-57: Editing the Training/Test protocol

The individual parameters (light gray fields) can now be edited by touching the display or by repeatedly tapping [↕]. If you need to input characters (numbers or letters), an (alpha-) numeric keypad or a keyboard will be displayed.

The options for Type are [Pulse ↕], [Constant ↕], [Interval ↕], [Ramp Test ↕], [PWC Test 1 ↕], [PWC Test 2 ↕], [PWC Test 3 ↕] and [Inactive ↕]. You scroll through the Type options by tapping the [↕] key. Configure the parameters as required by the selected type.

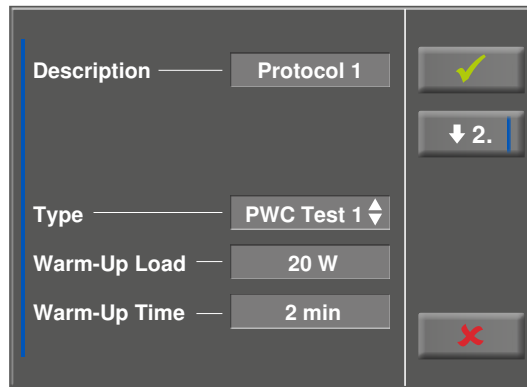

Figure 8-58: Editing parameters – screen 1

With the [↓] key (arrow down, [↓2.] or [↓3.]), you access the next menu level where more parameters can be configured. With the [↑] key (arrow up, [↑1.] or [↑2.]), you return to the previous screen.

Inputs are confirmed with the [✓] key.

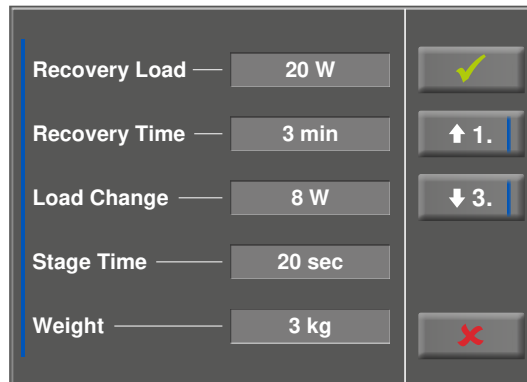

Figure 8-59: Editing parameters – screen 2

8.3.2.4 Manual

In this operating mode the user has complete control over the couch ergometer and initiates blood pressure measurements.

Pressing the [Start] key initiates the exercise test, the [+ 5 W] and [- 5 W] keys are used to control the load. The actual load change can be set in the configuration menu between +/- 1 W and +/- 25 W (see chapter 8.3.2.5 *Setup*, section *Load Change* on page 42)).

A blood pressure measurement is initiated with the [RR] key.

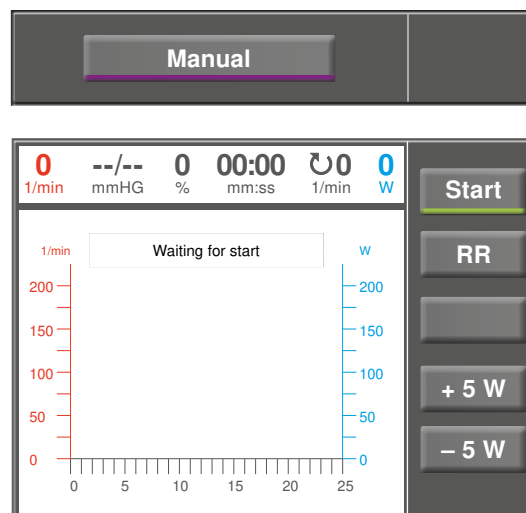

Figure 8 – 60: Starting a manual test

Terminating an Exercise Test

The exercise test can be terminated manually at any time with the [Stop] key.

The load will immediately drop to 0 watt.

There is no recovery phase in the manual mode.

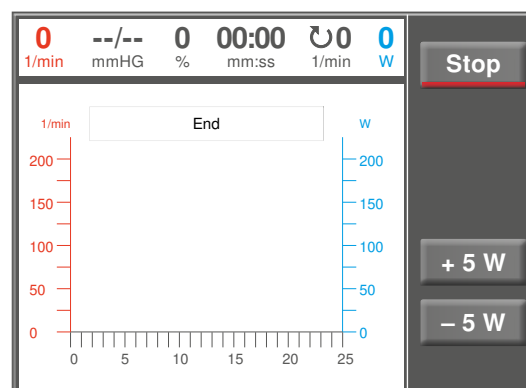

Figure 8 – 61: Terminating a manual test

8.3.2.5 Setup

The [Setup] key opens the configuration menu where various program functions can be defined.

To edit a setting, touch the corresponding menu item on the display.

Confirm inputs with the [✓] key and exit menus with the [✕] key.

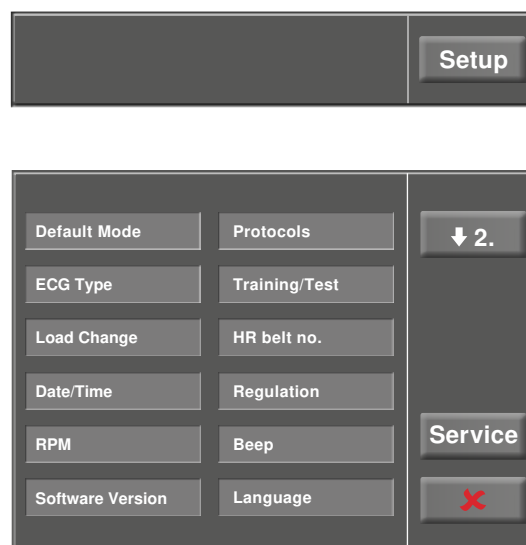

Figure 8 – 62: Setup menu

Default Mode

Select the operating mode to be activated when the couch ergometer is turned on:

- PC Mode
- Ergometry
- Training/Test
- Manual

and confirm the selection with the [✓] key.

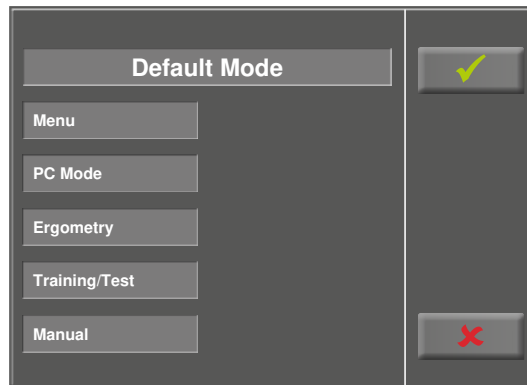

Figure 8 – 63: Default mode setup

Protocols

The first 5 exercise test protocols (WHO, BAL, Hollm, Std Fr and Standard) are preconfigured, but all protocols in the list are editable.

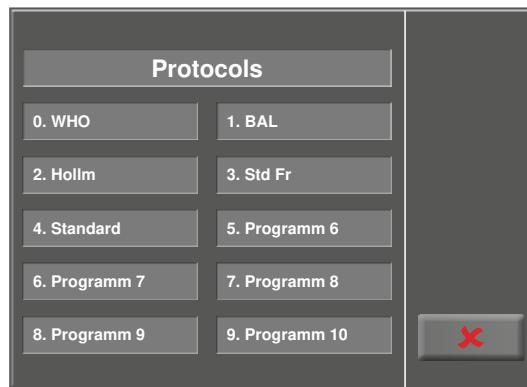

Figure 8 – 64: Setup – protocols, screen 1

To reach the level for editing of the individual protocol parameters, first touch the protocol that you want to modify (e.g., [5. Program 6]), and then touch the [Edit] key.



Figure 8 – 65: Setup – protocols, screen 2

To change the name of a protocol, touch the protocol name and enter the new name from the keypad. Confirm your inputs with the [✓] key.

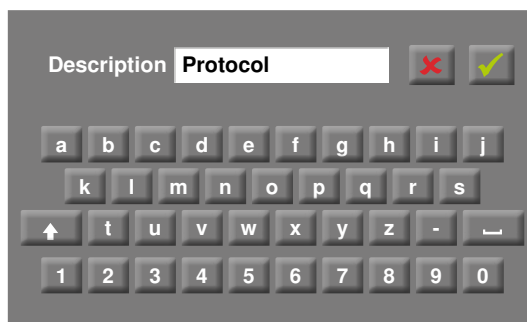

Figure 8 – 66: Setup – protocols, screen 3

At Type, you can choose [Step ↕], [Ramp ↕] or [Inactive ↕]. You scroll through the Type options with the [↕] key.

When choosing the Step type (load increase in steps), define the basic load (from 6 to 100 W), the stage time (from 1 to 30 min) and the stage rate (increment, from 1 to 400 W). When choosing the Ramp type (continuous load increase), define the basic load (from 6 to 100 W) and the load increase (from 1 to 50 W).

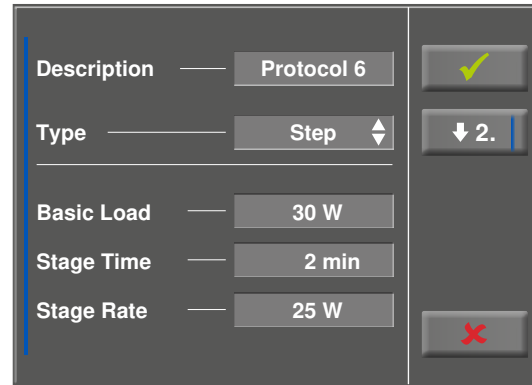

Figure 8–67: Setup – protocols, screen 4

To configure the protocol parameters (light gray fields), touch one of the parameters. Edit the parameter as appropriate and confirm the modification with the [✓] key.

Touch the Cancel key [✕] to conclude the parameter change.

With the [↓ 2.] and [↑ 1.] keys, you toggle between the different screens.

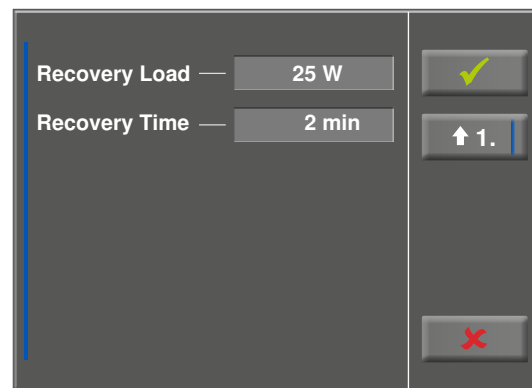

Figure 8–68: Setup – protocols, screen 5

ECG Type

The selected ECG Type determines the communication method with the ECG recorder, PC-based ECG system, etc.

To prevent an accidental change, this setting is protected with a password.

A submenu opens when you touch ECG Type on the display. Enter the code number "3" via the numeric keypad and confirm with the [✓] key.

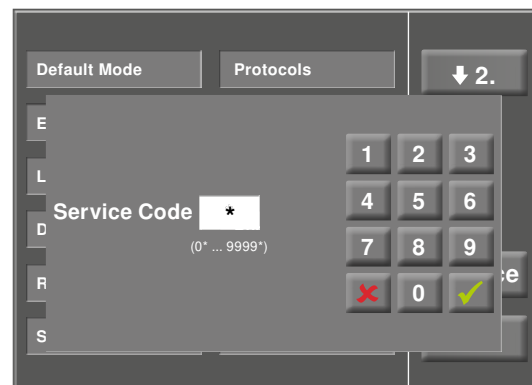

Figure 8–69: Setup menu

8 Control Terminals

The following communication modes are supported:

- **Analog with pulse**
Remote start mode; before advancing to the next load level, the couch ergometer generates a control pulse and sends the corresponding data via the interface.
- **Analog/Digital**
An analog voltage controls the load – blood pressure measurements can be initiated with digital commands.
- **Digital** (default)
The communication with the couch ergometer is entirely controlled with digital commands.
- **Analog IN-OUT**
The entire communication (load control and BP measurements) is controlled with analog signals. No digital data will be sent.

Choose the appropriate communication mode and confirm with the [✓] key.

Load Change

With this function, you select the increments for load changes.

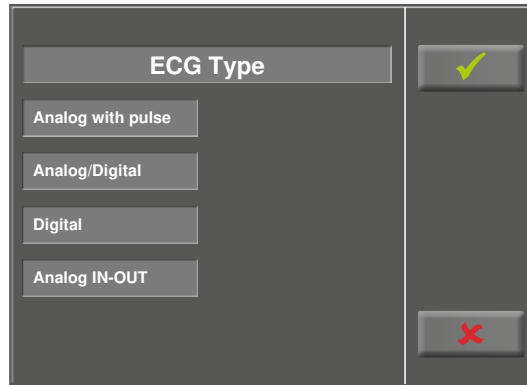

Figure 8–70: Setup – ECG Type

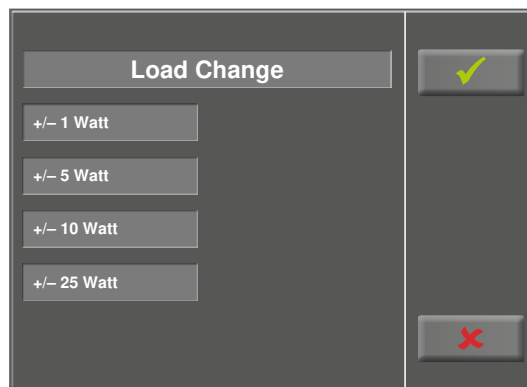

Figure 8–71: Load change setup

Date/Time

Touch the respective fields to adjust date and time.

Enter day, month, year as well as hours, minutes and seconds via the numeric keypad.

Inputs are confirmed with the [✓] key.

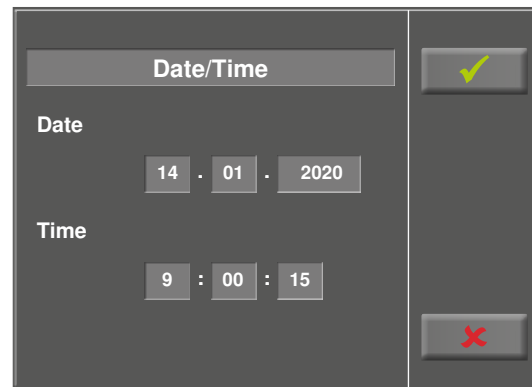

Figure 8-72: Setup – date and time, screen 1

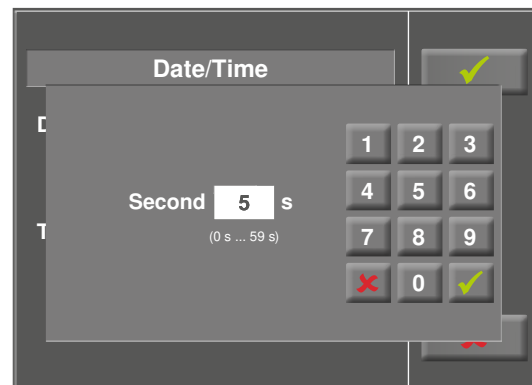

Figure 8-73: Setup – date and time, screen 2

Regulation

At Regulation, you can specify the load details:

- load control (flat, normal, steep)
- duration: load + (0 min to 15 min) and
- duration load – (0 min to 15 min)

You scroll through the load control options (flat, normal, steep) by tapping the light gray text field.

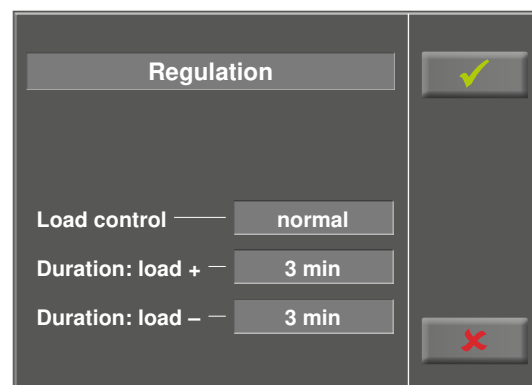

Figure 8-74: Setup – regulation method, screen 1

When you touch the light gray fields to the right of 'Duration: load +' or 'Duration: load -', the time can be entered via the numeric keypad.

Inputs are confirmed with the [✓] key.

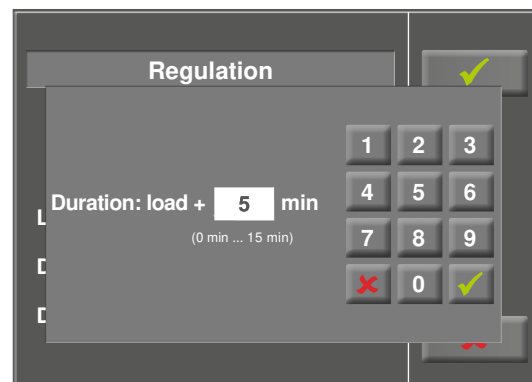

Figure 8-75: Setup – regulation method, screen 2

RPM

In this menu, you determine the limits for the RPM indication.

The 3 LEDs on the control panel show the patient whether the pedal speed is high, low or correct.

Touch the light gray field to the right of Min. or Max. and enter the value via the numeric keypad.

Confirm the input with the [✓] key or cancel the input with the [✗] key.

Beep

A short beep confirms each key press. The audible feedback can be enabled and disabled.

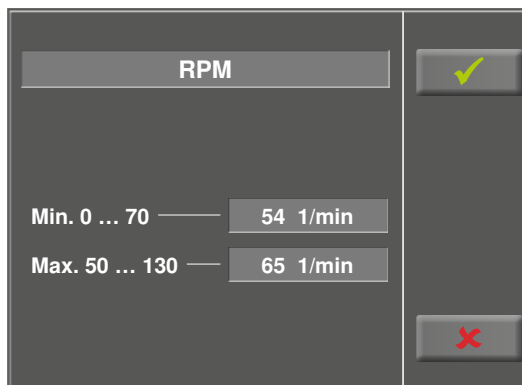

Figure 8–76: Setup – RPM, screen 1

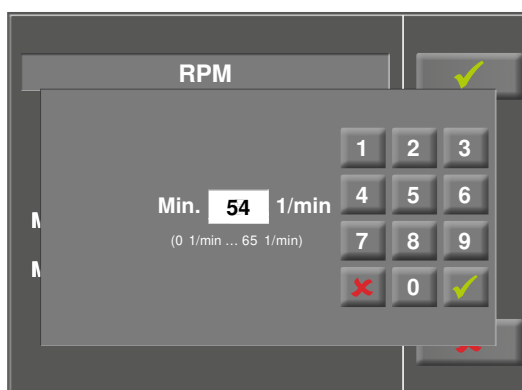

Figure 8–77: Setup – RPM, screen 2



Figure 8–78: Beep setup

Software Version

This menu shows the software version and the date of the technical inspection of the measuring system (MTK).

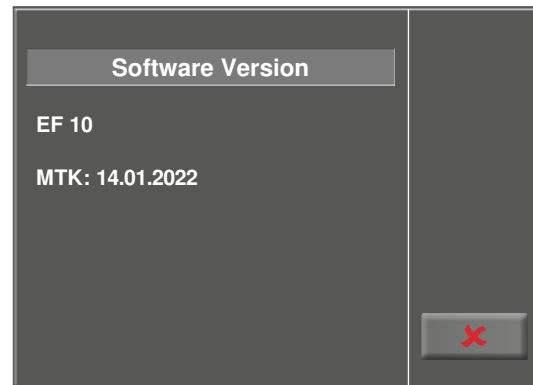

Figure 8 – 79: Setup – software version

Language

Here you choose the language for the user interface.



Figure 8 – 80: Language setup

Display

Press the [▼2.] key to display the next screen and touch Display.

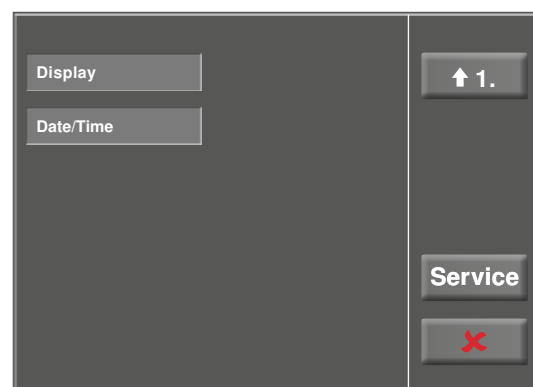

Figure 8 – 81: Setup – screen display 1

8 Control Terminals

Switch the pulse readout on or off.

Select the blood pressure unit: mmHg (millimeter of mercury) or kPa (kilopascal).

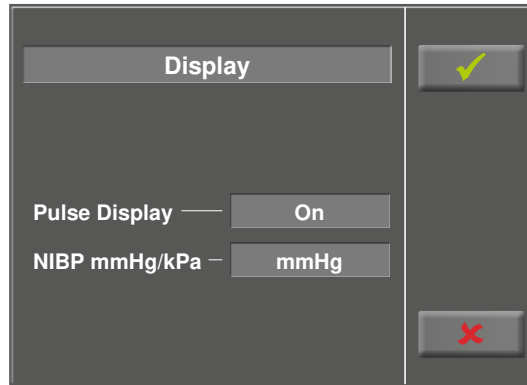

Figure 8-82: Setup – screen display 2

9 Cleaning, Maintenance, Disposal

9.1 General Cleaning

Wipe the device surface down with a cloth moistened with soap water or a disinfectant.

The cloth should not be dripping wet; do not allow liquids to enter the device.

9.2 Cleaning the Upholstery

Wipe the upholstery down with a soft cloth moistened with soap water.

The cloth should only be moist and not dripping wet.

If the cleaning agents and disinfectants used are caustic or contain alcohol, they may damage and/or discolor the upholstery.

9.3 Cleaning the Saddle

Clean the saddle with a soft and dry or moist cloth. **Disinfectants used should not contain alcohol.**

9.4 Disinfection

The following disinfectants are approved for disinfection:

Schülke & Mayr GmbH:

- Antifect® AF, FF, FD 10
- Terralin® (0.5 ‰)
- Quartamon Med®

B. Braun Melsungen AG:

- Hexaquart plus® (0.5 ‰ / 5.0 ‰)
- Hexaquart S® (1.5 ‰ / 5.0 ‰)
- Meliseptol®
- Melsept SF® (0.5 ‰ / 5.0 ‰)

ECOLAB:

- Incidin Foam®

Warning

- **Shock Hazard** •

- *Disconnect the device from the power line before cleaning.*

- **Equipment Damage** •

- *Do not allow liquids to enter the device. Devices into which liquids have entered must be immediately cleaned and checked by a service technician, before they can be reused.*
- *Do not use acids, alkaline solutions (household cleaners) or caustic disinfectants.*

Note

Do not use cleaning agents or disinfectants that contain alcohol.

Note

Strictly observe the manufacturer's instructions for use.

9.5 Cleaning the Blood Pressure Cuff

9.5.1 Removing the Microphone

Pull the end of the cuff through the metal clasp and fold out the cuff.

Pull on the short Velcro tab to open the microphone pocket and carefully remove the microphone.

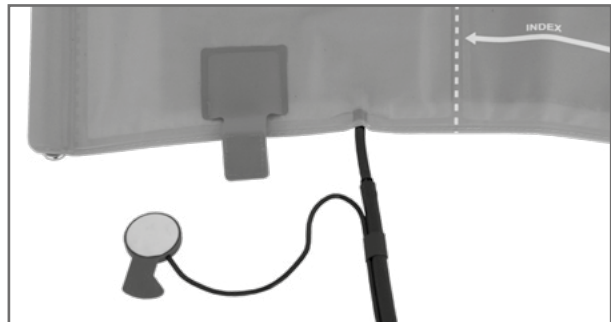

Figure 9 – 1: Removing the microphone

9.5.2 Cleaning

Clean the cuff and tubing with a moist cloth. You can use a dishwashing liquid or mild soap water (do NOT use cleaning agents containing alcohol).

Clean the microphone with a cloth moistened with alcohol or soap water.

Allow the microphone to dry before reinserting it in its pocket.

9.5.3 Disinfection

For disinfection, spray a disinfectant sparingly on the cuff, the tubing and the microphone. After the contact time indicated by the manufacturer, wipe all components dry.

The following disinfectants are approved for disinfection:

Schülke & Mayr GmbH:

- Antifect® AF, FF, FD 10
- Terralin® (0.5 ‰)
- Quartamon Med®

B. Braun Melsungen AG:

- Hexaquart plus® (0.5 ‰ / 5.0 ‰)
- Hexaquart S® (1.5 ‰ / 5.0 ‰)
- Meliseptol®
- Melsept SF® (0.5 ‰ / 5.0 ‰)

ECOLAB:

- Incidin Foam®

Warning

• Equipment Damage •

- Cuff, microphone and tubing may not under any circumstances:
 - be immersed in liquid
 - be cleaned in a water bath or in running water

Note

Strictly observe the manufacturer's instructions for use.

9.5.4 Inserting the Microphone

Slip the microphone into the pocket, the metal side facing the arm.

Guide the microphone cable out of the pocket and to the right of the Velcro tab. Then close the tab.

Fold the end of the cuff over and introduce it into the metal clasp.

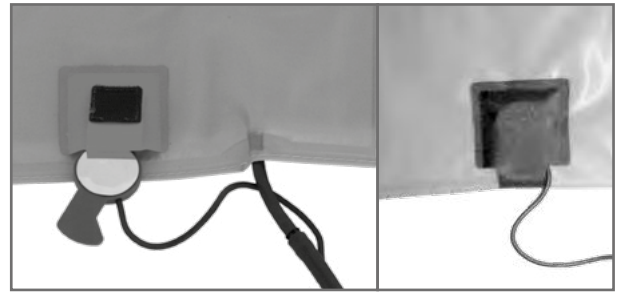

Figure 9-2: Inserting the microphone

9.6 Maintenance

9.6.1 Checks Before Each Use

Before each use, visually inspect the device for signs of mechanical damage. If you detect damage or impaired functions which may result in a hazard to the patient or the operator, the device must be repaired before it can be used again.

9.6.2 Technical Safety Inspections and Inspections of the Measuring System

The technical safety inspections and the inspections of the measuring system must be completed every two years according to the rules of the art by a Service Engineer authorized by ergoline GmbH.

Similarly, the automatic sphygmomanometer in the control terminal must be checked and, if necessary, calibrated by an authorized specialist every two years to fulfill legal requirements.

The date of the next inspection is indicated on the inspection sticker attached next to the type plate on the couch ergometer.

9.7 Disposal

The product described in this operator manual must not be disposed as unsorted municipal waste; it must be collected separately.

Please contact your authorized manufacturer ergoline GmbH for information concerning the disposal of your equipment. There is no waste disposal certificate. Proper disposal is documented by ergoline GmbH. Consult Operating Manual!



Note

The (rechargeable) batteries that power the motor controller in the device must not be disposed of as unsorted municipal waste. They must be disposed of as hazardous waste.

Used (rechargeable) batteries may contain harmful substances which can endanger human health and harm the environment if stored or disposed of improperly.

10 Technical Specifications

10.1 Ergometer

Model	modular couch ergometer system ergoselect model ergoselect 12 M/P/T
Operating mode	continuous operation (ergometry unit)
Power	90 – 264 V / 47 – 63 Hz / 200 VA max. fuses: 2 x T 2.5 AH
Braking principle	computer-controlled eddy current brake
Load range	6 – 450 watts (1000 watts optional), speed-independent
Speed range	30 – 130 RPM
Load accuracy	to DIN VDE 0750-238
Load increments	user-configurable (control terminals P/T)
Internal protocols	<p>Control Terminal P:</p> <ul style="list-style-type: none"> • 5 fixed and 5 user-programmable exercise test protocols • manual load control <p>Control Terminal T:</p> <ul style="list-style-type: none"> • 10 exercise test protocols (5 preconfigured, editable and 5 user-configurable protocols) • 10 additional, user-programmable training/exercise test protocols • manual load control • 3 preprogrammed performance tests
Permitted patient weight	200 kg
Saddle adjustment	motor-assisted, continuous adjustment via remote control
Swivel range of the couch surface	0 to 45° each; continuous, motor-assisted adjustment via remote control, 3 user-programmable positions
Crank length	170 mm
Displays	<p>Control Terminal T: TFT LCD, 165 x 104 mm, 800 x 480 pixels</p> <p>Control Terminals M and P: LCD, 68 x 34 mm, 128 x 64 pixels</p>
Interfaces	RS-232, USB Bluetooth (option) WLAN (option)
Dimensions, weight	<p>couch surface: 200 cm x 65 cm</p> <p>device: ca. 220 cm x 90 cm x 180 cm (L x W x H) in maximum tilt position</p> <p>weight: approx. 240 kg</p>

Safety standards	DIN EN 60601-1, DIN EN 60601-1-2, DIN VDE 0750-238
Protection class/degree of protection	I / B (stress-echo couch ergometer) BF (blood pressure module)
MDD classification	class IIa to 93/42 EEC
RF emission	class A to DIN EN 55011 (VDE 0875-11)/ 04/2011, DIN EN 60601-1-2
Environment	operation: temperature: +10 to +40 °C rel. humidity: 30 to 75%, no condensation atmospheric pressure: 800 to 1060 hPa transport and storage: temperature: -20 to +70 °C rel. humidity: 10 to 95%, no condensation atmospheric pressure: 500 to 1060 hPa
Type of protection	IP 21

10.2 Blood Pressure Module

Measuring method	auscultatory method (Korotkov), oscillometric; for resting BP, the results from both measurements are compared for plausibility
Measuring range	systolic pressure: 40 to 280 mmHg diastolic pressure: 40 to 280 mmHg pulse rate: 35 to 230 bpm
Measurement error, systematic	systolic pressure: +/- 3 mmHg diastolic pressure: +/- 3 mmHg (temperature: +15 to +25 °C)
Standard deviation (clinical trial)	systolic/diastolic pressure: 7 mmHg (max.)
Inflation pressure	300 mmHg max.; during inflation the inflation pressure automatically adapts to patient's BP
Inflation rate	between approx. 6 seconds (to 140 mmHg) and approx. 18 seconds (to 300 mmHg)
Max. cuff pressure	300 mmHg
Cuff deflation method	pulse-dependent deflation rate approx. 3 mmHg/beat or approx. 3 mmHg/s
Calibration	calibration with external pressure meter
Artifact rejection	automatic artifact rejection and comparison of both measuring methods for plausibility during measurement of the baseline pressure at rest

10.3 Exercise Test Protocols

Protocol	Basic Load [W]	Stage Time [min]	Load Stage [W]	Recovery Load [W]	Recovery Time [min]
1. WHO	25	2	25	25	99
2. BAL	50	3	50	25	99
3. Hollmann	30	3	40	25	99
4. STD France	30	3	30	25	99
5. Standard	20	1	25	25	99
6. – 15. (user programmable)	25	2	25	25	99
Adjustment Range	20 – 100	1 – 30	1 – 400	20 – 100 (*)	1 – 99

(*) With Control Terminal P, the recovery load is fixed at 25 W.

10.4 Test Protocols (control terminal T only)

Protocol	Basic Load [W]	Duration [sec]	Load Change [W]	Stage Time [sec]	Recovery Load [W]	Recovery Time [min]
Ramping protocol	0	120	25	10	25	99
PWC-130 (*)	25	0	25	120	25	99
PWC-150 (*)	50	0	25	120	25	99
PWC-170 (*)	50	0	50	120	25	99

(*) the protocol advances to the recovery phase as soon as the target heart rate (130/150/170) is reached

10.5 Family of characteristics of the braking torque control range

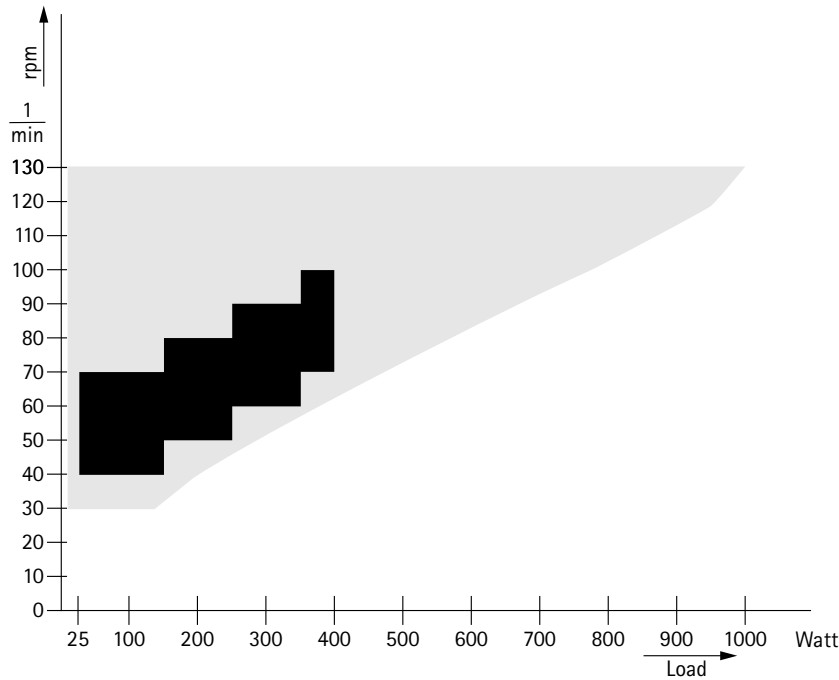

Figure 10-1: black: speed-independent range to DIN VDE 0750-0238
 black + gray: speed-independent range of the ergoselect ergometer

10.6 Family of characteristics of the load periods according to IEC 60601-1

Watt	0	20	40	60	80	100	120	140	160	180	200	220	240
999	14	28	6	40	6	40	6	40	6	40	6	40	6
900	18	28	7	36	7	36	7	36	7	36	7	36	7
800	23	28	9	32	9	32	9	32	9	32	9	32	9
700	29	28	11	29	11	29	11	29	11	29	11	29	11
600	35	28	14	28	14	28	14	28	14	28	14	28	14
500	48	28	19	28	19	28	19	28	19	28	19	28	19
400	72	28	26	28	26	28	26	28	26	28	26	28	26
350	99	28	38	28	38	28	38	28	38	28	38	28	38
300	∞												

Figure 10-2: Under permanent load, the load periods and pauses (white) shall be observed.

11 Electromagnetic Compatibility EN 60601-1-2

Changes or modifications to this system not expressly approved by ergoline GmbH could cause EMC issues with this or other equipment.

This system is designed to comply with applicable regulations regarding EMC.

Its compliance with these requirements has been verified. It needs to be installed and put into service according to the EMC information stated as follows.

Warning

- RF Interference •

Use of portable phones or other radio frequency (RF) emitting equipment near the system may cause unexpected or adverse operation.

Caution

- Equipment Malfunction •

The equipment or system should not be used adjacent to, or stacked with, other equipment. If adjacent or stacked use is necessary, the equipment or system should be tested to verify normal operation in the configuration in which it is being used.

Guidance and Manufacturer's Declaration – Electromagnetic Emissions		
The ergoselect ergometer is intended for use in the electromagnetic environment specified below. It is the responsibility of the customer or user to ensure that the ergoselect ergometer is used in such an environment.		
Emissions Test	Compliance	Electromagnetic Environment – Guidance
RF emissions to EN 55011	Group 1	The ergoselect ergometer uses RF energy only for its internal function. Therefore, its RF emissions are very low and are not likely to cause any interference in nearby electronic equipment.
RF emissions to EN 55011	Class A	The device characteristics determined by emissions allow the device to be used in industrial environments and in hospitals (CISPR 11, class A). When used in domestic surroundings (which normally requires compliance with CISPR 11 class B), the device may not offer adequate protection for radio services. If required, the user may have to take remedial action by relocating or re-orienting the device.
Harmonic emissions to EN 61000-3-2	Class A	
Voltage fluctuations/flicker emissions to EN 61000-3-3	Complies	

Guidance and Manufacturer's Declaration – Electromagnetic Immunity			
The ergoselect ergometer is intended for use in the electromagnetic environment specified below. It is the responsibility of the customer or user to ensure that the ergoselect ergometer is used in such an environment.			
Immunity Test	IEC 60601 Test Level	Compliance Level	Electromagnetic Environment – Guidance
Electrostatic discharge (ESD) to EN 61000-4-2	± 2 kV contact ± 2 kV air ± 4 kV air ± 8 kV air ± 15 kV air	± 2 kV passed ± 15 kV passed	Floors should be wood, concrete or ceramic tile. If floors are covered with synthetic material, the relative humidity should be at least 30 %.
Electrical fast transient/burst to EN 61000-4-4	± 2 kV for power supply lines ± 1 kV for input/output lines	± 2 kV passed	Mains power should be that of a typical commercial or hospital environment.
Surge to EN 61000-4-5	± 0.5 / 1 kV L-N ± 0.5 / 1 / 2 kV L-PE ± 0.5 / 1 / 2 kV N-PE	± 1 kV passed ± 2 kV passed ± 2 kV passed	Mains power should be that of a typical commercial or hospital environment.
Voltage dips, short interruptions and voltage variations on power supply input lines to EN 61000-4-11	0% / 0.5 periodic from 0° to 315° in steps of 45°	passed	Mains power should be that of a typical commercial or hospital environment. If the user of the ergoselect ergometer requires continued operation during power mains interruptions, it is recommended that the ergoselect ergometer be powered from an uninterruptible power supply or a battery.
	0% / 1 periodic	passed	
	70% / 25 periodic	passed	
	0% / 250 periodic	passed	
Power frequency (50/60 Hz) magnetic field to EN 61000-4-8	30 A/m	passed	Power frequency magnetic fields should be at levels characteristic of a typical location in a typical commercial or hospital environment. The ergoselect ergometer has no components susceptible to magnetic fields.
Note: UT is the a.c. mains voltage prior to application of the test level.			

Guidance and Manufacturer's Declaration – Electromagnetic Immunity			
The ergoselect ergometer is intended for use in the electromagnetic environment specified below. It is the responsibility of the customer or user to ensure that the ergoselect ergometer is used in such an environment.			
Immunity Test	IEC 60601 Test Level	Compliance Level	Electromagnetic Environment – Guidance
<p>Conducted RF to EN 61000-4-6</p> <p>Radiated RF to EN 61000-4-3</p>	<p>3 Vrms 150 kHz to 80 MHz</p> <p>3 V/m 80 MHz to 2.7 GHz</p>	<p>3 V</p> <p>3 V/m</p>	<p>Portable and mobile RF communications equipment should be used no closer to any part of the ergoselect ergometer, including cables, than the recommended separation distance calculated from the equation applicable to the frequency of the transmitter.</p> <p>Recommended separation distance: $d = 1.2 \sqrt{P}$ $d = 1.2 \sqrt{P}$ for 80 MHz to 800 MHz $d = 2.3 \sqrt{P}$ for 800 MHz to 2.5 GHz</p> <p>where P is the maximum output power rating of the transmitter in watts (W) according to the transmitter manufacturer and d is the recommended separation distance in meters (m).</p> <p>Field strengths from fixed RF transmitters, as determined by an electromagnetic site survey (a), should be less than the compliance level in each frequency range (b).</p> <p>Interference may occur in the vicinity of equipment marked with the following symbol:</p> 
<p>Note 1: At 80 MHz and 800 MHz, the higher frequency range applies.</p> <p>Note 2: These guidelines may not apply in all situations. Electromagnetic propagation is affected by absorption and reflection from structures, objects, and people.</p>			
<p>(a) Field strengths from fixed transmitters, such as base stations for radio (cellular/cordless) telephones and land mobile radio, amateur radio, AM and FM radio broadcast and TV broadcast cannot be predicted theoretically with accuracy. To assess the electromagnetic environment due to fixed RF transmitters, an electromagnetic site survey should be considered. If the measured field strength in the location in which the ergoselect ergometer is used exceeds the applicable RF compliance level above, the ergoselect ergometer should be observed to verify normal operation. If abnormal performance is observed, additional measures may be necessary, such as re-orienting or relocating the ergoselect ergometer.</p> <p>(b) Over the frequency range from 150 kHz to 80 MHz, field strengths should be less than 3 V/m.</p>			

Recommended separation distances between portable and mobile RF communications equipment and the ergoselect ergometer			
The ergoselect ergometer is intended for use in an electromagnetic environment, as specified below, in which radiated RF disturbances are controlled. The customer or the user of the ergoselect ergometer can help prevent electromagnetic interference by maintaining a minimum distance between portable and mobile RF communications equipment (transmitters) and the ergoselect ergometer as recommended below, according to the maximum output power of the communications equipment.			
Rated maximum output power of transmitter [W]	Separation distance according to frequency of transmitter in meters		
	150 kHz to 80 MHz $d = 1.2 \sqrt{P}$	80 MHz to 800 MHz $d = 1.2 \sqrt{P}$	800 MHz to 2.5 GHz $d = 2.3 \sqrt{P}$
0.01	0.12	0.12	0.23
0.1	0.37	0.37	0.74
1	1.17	1.17	2.33
10	3.7	3.7	7.37
100	11.7	11.7	23.3
For transmitters rated at a maximum output power not listed above, the recommended separation distance d in meters (m) can be estimated using the equation applicable to the frequency of the transmitter, where P is the maximum output power rating of the transmitter in watts (W) according to the transmitter manufacturer.			
Note 1: At 80 MHz and 800 MHz, the higher frequency range applies.			
Note 2: These guidelines may not apply in all situations. Electromagnetic propagation is affected by absorption and reflection from structures, objects, and people.			

12 Mounting the Safety Belt*

Mounting the safety belt



Figure 12-1: 1 Safety belt
2 Belt padding

To mount the safety belt with padding on the couch ergometer, adjust the position of the holder 3 with the belt on the lateral standard rail (see chapter 4.4 *Mounting Attachment Parts* on page 11).



Figure 12-2: Holder for safety belt

The holder with the safety belt can be shifted on the standard rail so that the ideal position for each patient can be found.

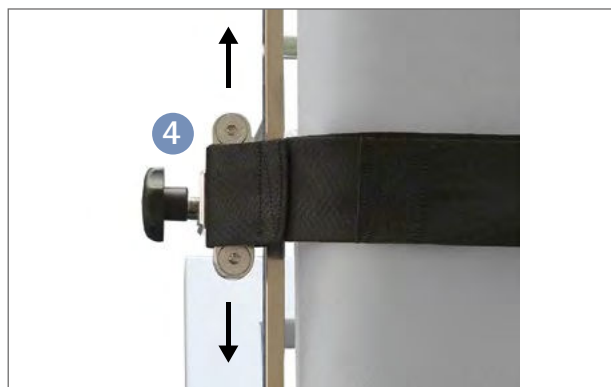

Figure 12-3: Adjusting the safety belt position on the couch ergometer

* Accessories (optional)

When the holder with the safety belt is in the correct position, tighten the set screw to secure the holder with the safety belt to the couch.

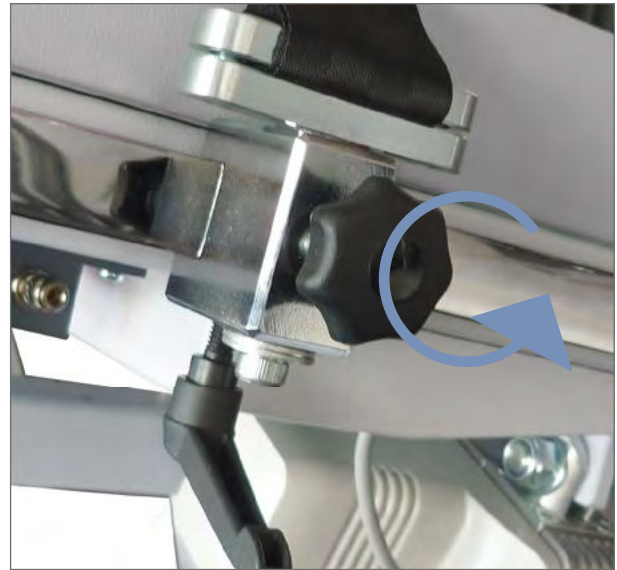

Figure 12-4: Securing the safety belt

You can modify the length of the safety belt by means of the adjustable tongue of the belt.

Close the safety belt by inserting the tongue into the buckle until you hear a click.

To open the belt, press the red Press button on the buckle.



Figure 12-5: Adjusting and closing the safety belt

- ① Webbing strap
- ② Belt buckle
- ③ Belt tongue

Before use, check that the belt is firmly secured by the tightened set screw.

To remove the safety belt from the couch, open the set screw and remove the safety belt with the holder from the standard rail.

Note

The safety belt can be used with or without the hip support.



ergoline GmbH
Lindenstraße 5
72475 Bitz
Germany

Tel.: +49-(0) 7431 98 94 - 0
Fax: +49-(0) 7431 98 94 - 128
e-mail: info@ergoline.com
http: www.ergoline.com